

JVC

SERVICE MANUAL

DVD/CD RECEIVER

**KD-DV5201EU, KD-DV5202EU,
KD-DV5205U, KD-DV5205UT,
KD-DV5206U, KD-DV5206UT,
KD-DV6205U, KD-DV6205UT,
KD-DV6205A, KD-DV6206U,
KD-DV6206UT, KD-DV6206A**

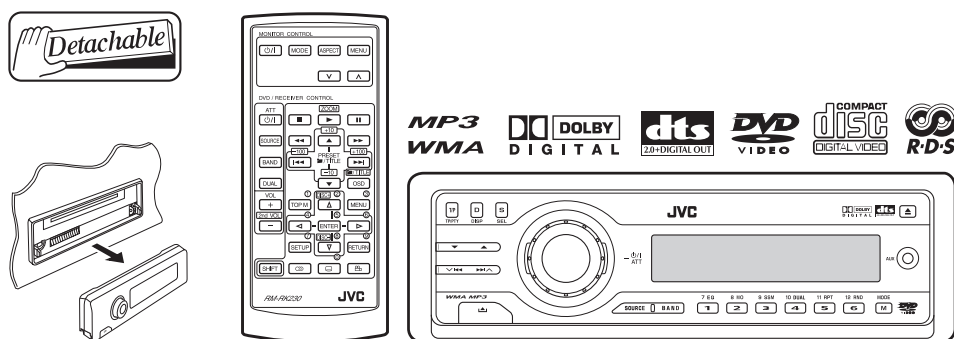

Lead free solder used in the board (material : Sn-Ag-Cu, melting point : 219 Centigrade)

TABLE OF CONTENTS

1	PRECAUTION.....	1-4
2	SPECIFIC SERVICE INSTRUCTIONS.....	1-4
3	DISASSEMBLY.....	1-4
4	ADJUSTMENT.....	1-4
5	TROUBLESHOOTING.....	1-5

SPECIFICATION

KD-DV5202/KD-DV5201

AUDIO AMPLIFIER SECTION		
Maximum Power Output	Front	50 W per channel
	Rear	50 W per channel
Continuous Power Output (RMS)	Front	19 W per channel into 4 Ω , 40 Hz to 20 000 Hz at no more than 0.8% total harmonic distortion.
	Rear	19 W per channel into 4 Ω , 40 Hz to 20 000 Hz at no more than 0.8% total harmonic distortion.
Load Impedance		4 Ω (4 Ω to 8 Ω allowance)
Equalizer Control Range	Frequencies	60 Hz, 150 Hz, 400 Hz, 1 kHz, 2.4 kHz, 6 kHz, 15 kHz
	Level	± 10 dB
Signal-to-Noise Ratio		70 dB
Audio Output Level	Analog (2nd AUDIO OUT)	6 mW (at 16 Ω)
	Digital (DIGITAL OUT: Optical)	Signal wave length : 660 nm Output level : -21 dBm to -15 dBm
	Line-Out Level/Impedance	5.0 V/20 k Ω load (full scale) Output Impedance : 1 k Ω
Subwoofer-Out Level/Impedance		2.0 V/20 k Ω load (full scale)
Color System		PAL
Video Output (composite)		1 V _{p-p} /75 Ω
Other Terminals		LINE IN, CD changer
TUNER SECTION		
Frequency Range	FM	87.5 MHz to 108.0 MHz
	AM	(MW) 522 kHz to 1 620 kHz (LW) 144 kHz to 279 kHz
FM Tuner	Usable Sensitivity	11.3 dBf (1.0 μ V/75 Ω)
	50 dB Quieting Sensitivity	16.3 dBf (1.8 μ V/75 Ω)
	Alternate Channel Selectivity (400 kHz)	65 dB
	Frequency Response	40 Hz to 15 000 Hz
	Stereo Separation	30 Db
MW Tuner	Sensitivity	20 μ V
	Selectivity	35 dB
LW Tuner	Sensitivity	50 μ V
DVD/CD PLAYER SECTION		
Signal Detection System	Non-contact optical	pickup (semiconductor laser)
Number of Channels		2 channels (stereo)
Frequency Response	DVD, fs=48 kHz/96 kHz	16 Hz to 22 000 Hz
	VCD, CD, MP3, WMA	16 Hz to 20 000 Hz
Dynamic Range		96 dB
Signal-to-Noise Ratio		98 dB
Wow and Flutter		Less than measurable limit
MP3 (MPEG Audio Layer 3)		Max. Bit Rate : 320 kbps
WMA (Windows Media® Audio)		Max. Bit Rate : 192 kbps
GENERAL		
Power Requirement	Operating Voltage	DC 14.4 V (11 V to 16 V allowance)
Grounding System		Negative ground
Allowable Operating Temperature		0°C to +40°C
Dimensions (W × H × D)	Installation Size (approx.)	182 mm × 52 mm × 158 mm
	Panel Size (approx.)	188 mm × 58 mm × 11 mm
Mass (approx.)		1.7 kg (excluding accessories)

KD-DV6206/KD-DV6205/KD-DV5206/KD-DV5205

AUDIO AMPLIFIER SECTION		
Maximum Power Output	Front	50 W per channel
	Rear	50 W per channel
Continuous Power Output (RMS)	Front	19 W per channel into 4 Ω , 40 Hz to 20 000 Hz at no more than 0.8% total harmonic distortion.
	Rear	19 W per channel into 4 Ω , 40 Hz to 20 000 Hz at no more than 0.8% total harmonic distortion.
Load Impedance		4 Ω (4 Ω to 8 Ω allowance)
Equalizer Control Range	Frequencies	60 Hz, 150 Hz, 400 Hz, 1 kHz, 2.4 kHz, 6 kHz, 15 kHz
	Level	\pm 10 dB
Signal-to-Noise Ratio		70 dB
Audio Output Level	KD-DV6206/KD-DV6205	Analog (2nd AUDIO OUT) 6 mW (at 16 Ω)
	Digital (DIGITAL OUT: Optical)	Signal wave length : 660 nm Output level : -21 dBm to -15 dBm
	Line-Out Level/Impedance	5.0 V/20 k Ω load (full scale) (KD-DV6206/KD-DV6205) 2.5 V/20 k Ω load (full scale) (KD-DV5206/KD-DV5205) Output Impedance : 1 k Ω
Subwoofer-Out Level/Impedance		2.0 V/20 k Ω load (full scale) (KD-DV6206/KD-DV6205)
Color System		PAL/NTSC
Video Output (composite)		1 V _{p-p} /75 Ω
Other Terminals		LINE IN, CD changer
TUNER SECTION		
Frequency Range	FM	87.5 MHz to 108.0 MHz
	AM	531 kHz to 1 602 kHz
FM Tuner	Usable Sensitivity	11.3 dBf (1.0 μ V/75 Ω)
	50 dB Quieting Sensitivity	16.3 dBf (1.8 μ V/75 Ω)
	Alternate Channel Selectivity (400 kHz)	65 dB
	Frequency Response	40 Hz to 15 000 Hz
	Stereo Separation	30 dB
AM Tuner	Sensitivity	20 μ V
	Selectivity	35 dB
DVD/CD PLAYER SECTION		
Signal Detection System:	Non-contact optical	pickup (semiconductor laser)
Number of Channels		2 channels (stereo)
Frequency Response	DVD, fs=48 kHz/96 kHz	16 Hz to 22 000 Hz
	VCD, CD, MP3, WMA	16 Hz to 20 000 Hz
Dynamic Range		96 dB
Signal-to-Noise Ratio		98 dB
Wow and Flutter		Less than measurable limit
MP3 (MPEG Audio Layer 3)		Max. Bit Rate : 320 kbps
WMA (Windows Media® Audio)		Max. Bit Rate : 192 kbps
GENERAL		
Power Requirement	Operating Voltage	DC 14.4 V (11 V to 16 V allowance)
Grounding System		Negative ground
Allowable Operating Temperature		0°C to +40°C
Dimensions (W \times H \times D)	Installation Size (approx.)	182 mm \times 52 mm \times 158 mm
	Panel Size (approx.)	188 mm \times 58 mm \times 11 mm
Mass (approx.)		1.7 kg (excluding accessories)

Design and specifications are subject to change without notice.

SECTION 5 TROUBLESHOOTING

5.1 16 PIN CORD DIAGRAM (for KD-DV5201EU, KD-DV5202EU)

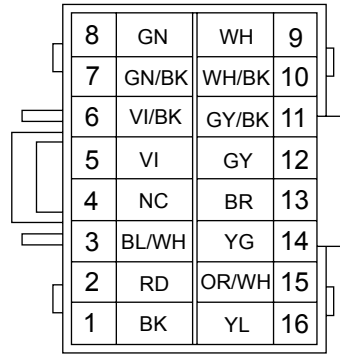

BK	Black	GN	Green
RD	Red	VI	Violet
BL	Blue	GY	Gray
WH	White	YL	Yellow
BR	Brown	OR	Orange
YG	Yellow Green		

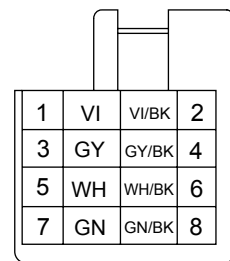
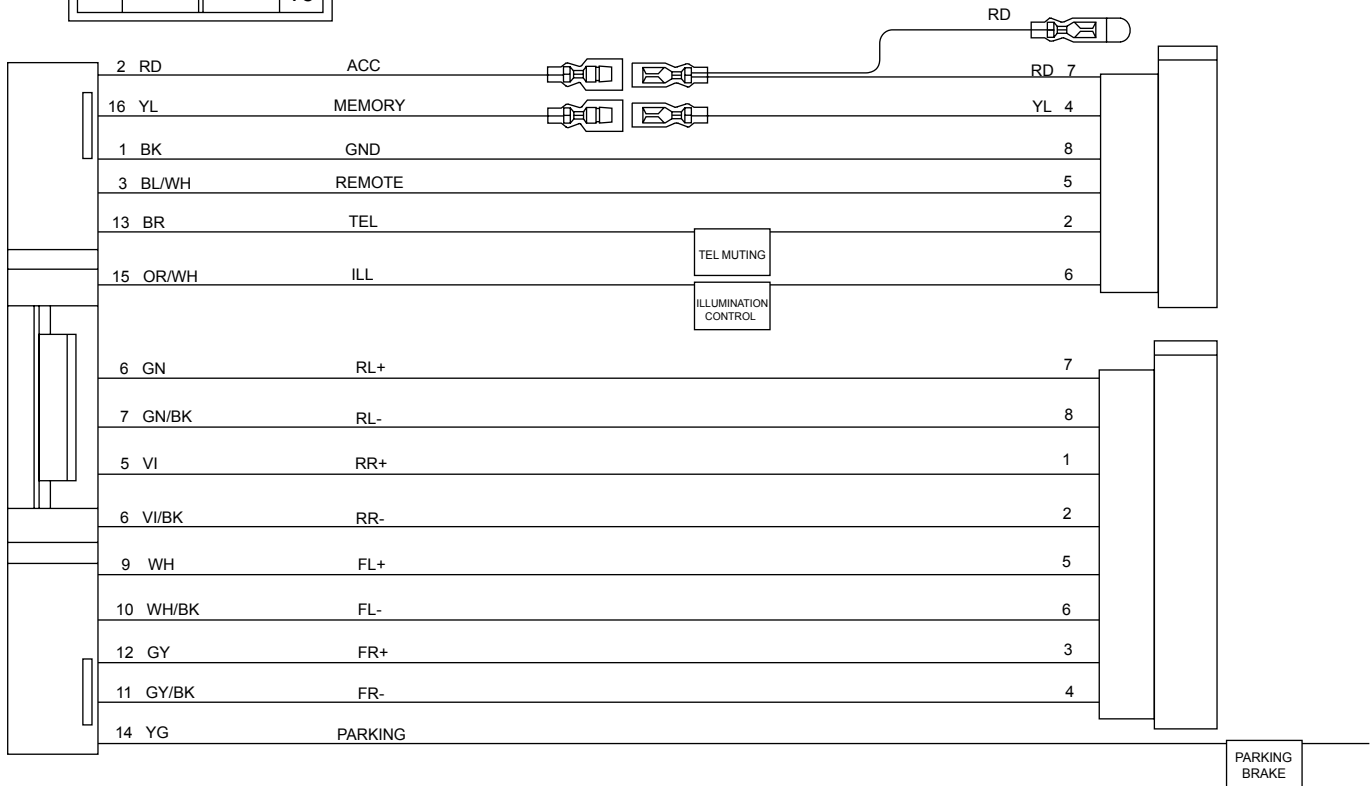
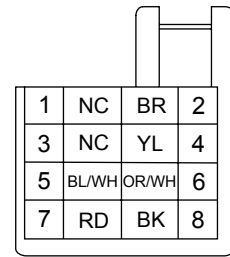

RR	Rear Right	ANT	Auto Antenna
FR	Front Right	ACC	ACC Line
FL	Front Left	TEL	Telephone Muting
RL	Rear Left	GND	Ground
REMOTE	Remote	MEMORY	Memory Backup Battery+
ILL	Illuminations Control	PARKING	Parking Brake

5.2 16 PIN CORD DIAGRAM (except KD-DV5201EU, KD-DV5202EU)

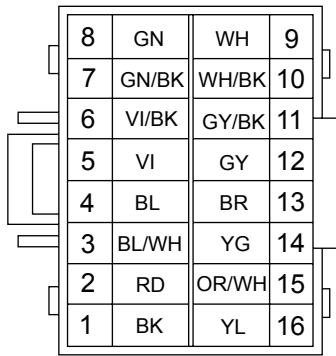

BK	Black	GN	Green
RD	Red	VI	Violet
BL	Blue	GY	Gray
WH	White	YL	Yellow
BR	Brown	OR	Orange
YG	Yellow Green		

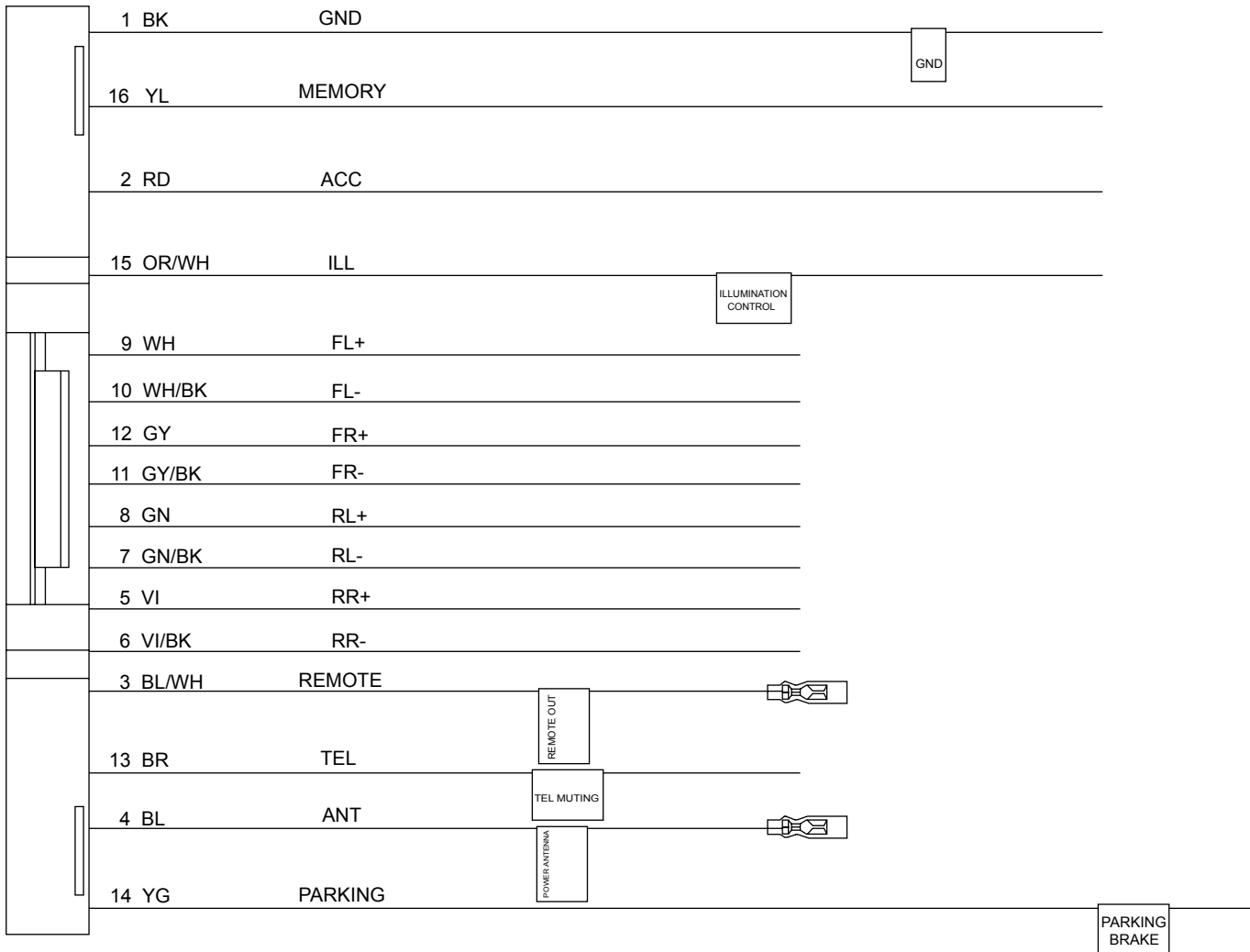

RR	Rear Right	ANT	Auto Antenna
FR	Front Right	ACC	ACC Line
FL	Front Left	TEL	Telephone Muting
RL	Rear Left	GND	Ground
REMOTE	Remote	MEMORY	Memory Backup Battery+
ILL	Illuminations Control	PARKING	Parking Brake

Standard schematic diagrams

■ Main section

(for KD-DV5201EU, KD-DV5202EU)

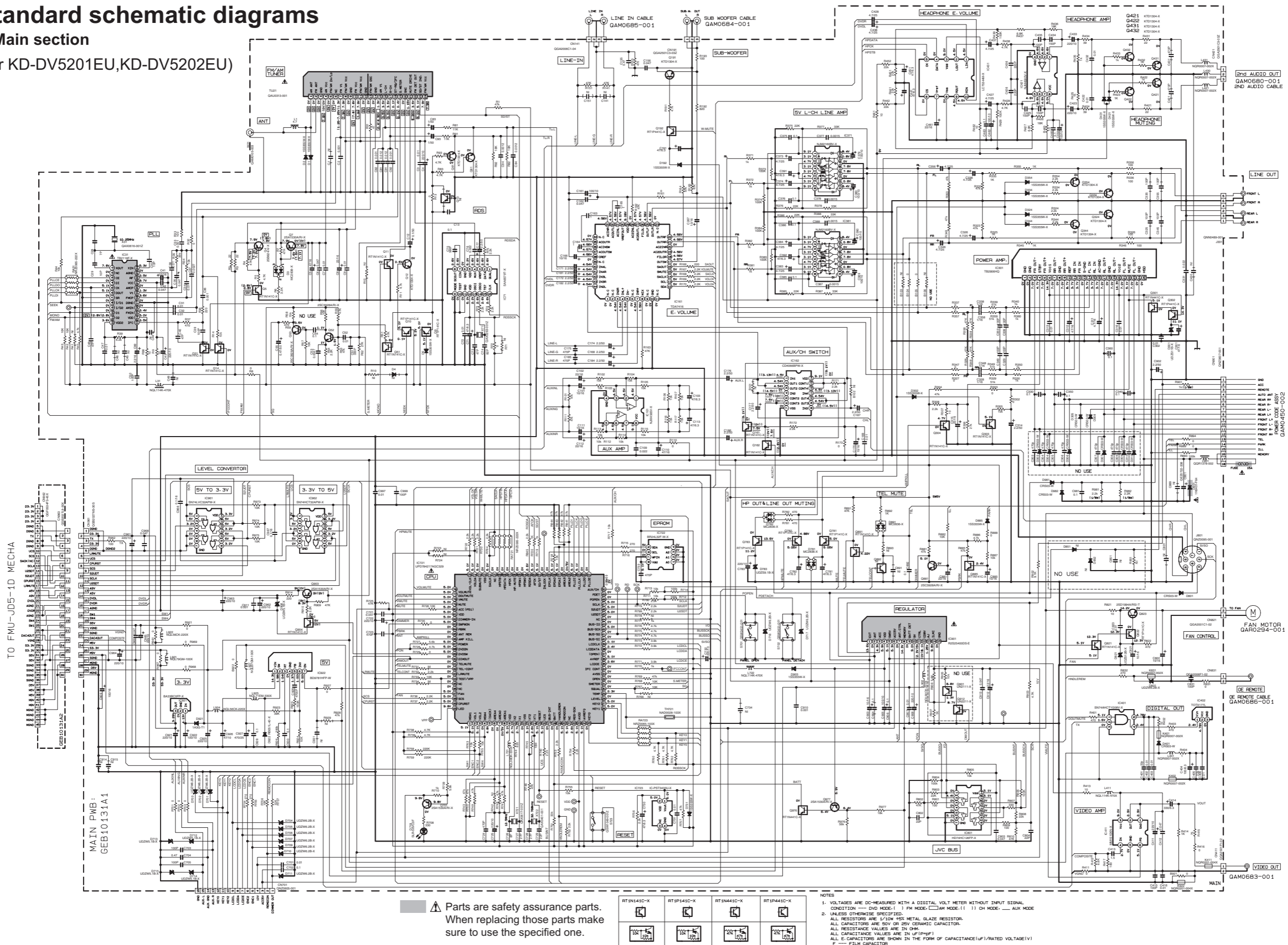

⚠ Parts are safety assurance parts.
When replacing those parts make
sure to use the specified one.

RT1N141C-X	RT1P141C-X	RT1N441C-X	RT1P441C-X

- NOTES
- VOLTAGES ARE DC-MEASURED WITH A DIGITAL VOLT METER WITHOUT INPUT SIGNAL. CONDITION: DVD MODE: () FM MODE: () CH MODE: () AUX MODE: ()
 - UNLESS OTHERWISE SPECIFIED, ALL RESISTORS ARE 1/16W 10% METAL GLAZE RESISTOR. ALL CAPACITANCE VALUES ARE IN UF (Ppf) UNLESS OTHERWISE SPECIFIED. ALL E-CAPACITORS ARE SHOWN IN THE FORM OF CAPACITANCE (UF)/RATED VOLTAGE (V). F = FILM CAPACITOR.
 - NI STANDS FOR NOT MOUNTED PARTS.

■ LCD and Key control section
(for KD-DV5201EU, KD-DV5202EU)

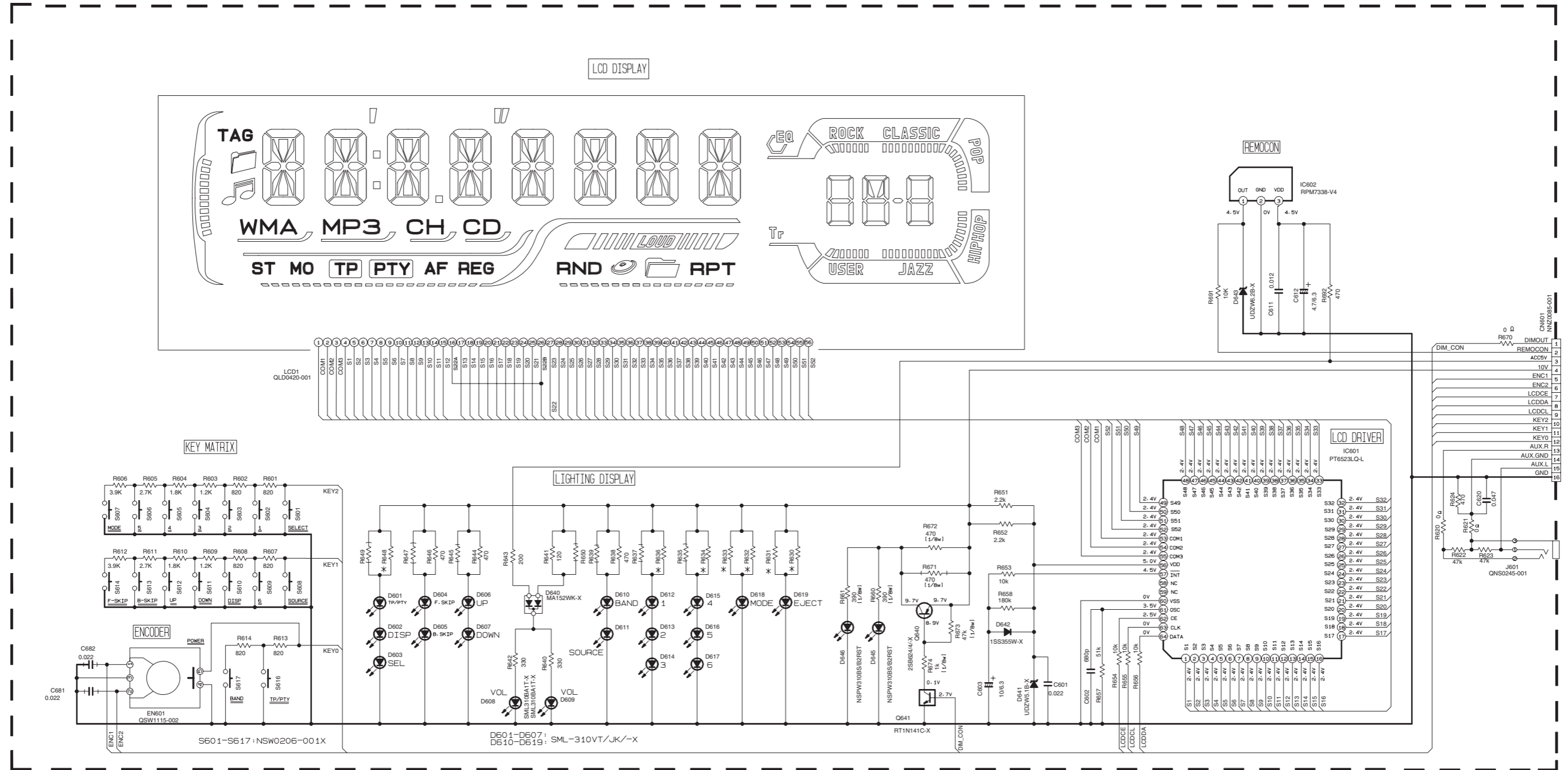

- NOTES
- VOLTAGES ARE DC-MEASURED WITH A DIGITAL VOLT METER WITHOUT INPUT SIGNAL.
 - UNLESS OTHERWISE SPECIFIED.
ALL RESISTORS ARE 1/16W METAL GLAZE RESISTORS.
ALL CAPACITORS ARE 50V OR 25V CERAMIC CAPACITOR.
ALL RESISTANCE VALUES ARE IN OHM.
ALL CAPACITANCE VALUES ARE IN uF(P=pF)
ALL E. CAPACITORS ARE SHOWN IN THE FORM OF CAPACITANCE(uF)/RATED VOLTAGE(V)
T --- TANTALUM CAPACITOR.
 - COMPONENTS IN () INDICATE NOT USE.

* REMARKS	KD-DV5201E	KD-DV5202E
R630	1K	1.2K
R631 R633	-	1.2K
R632	820	1.2K
R634 R636 R648	330	270

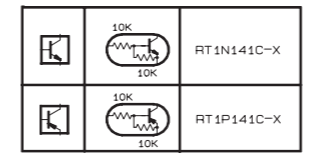

■ Main section
(except KD-DV5201EU, KD-DV5202EU)

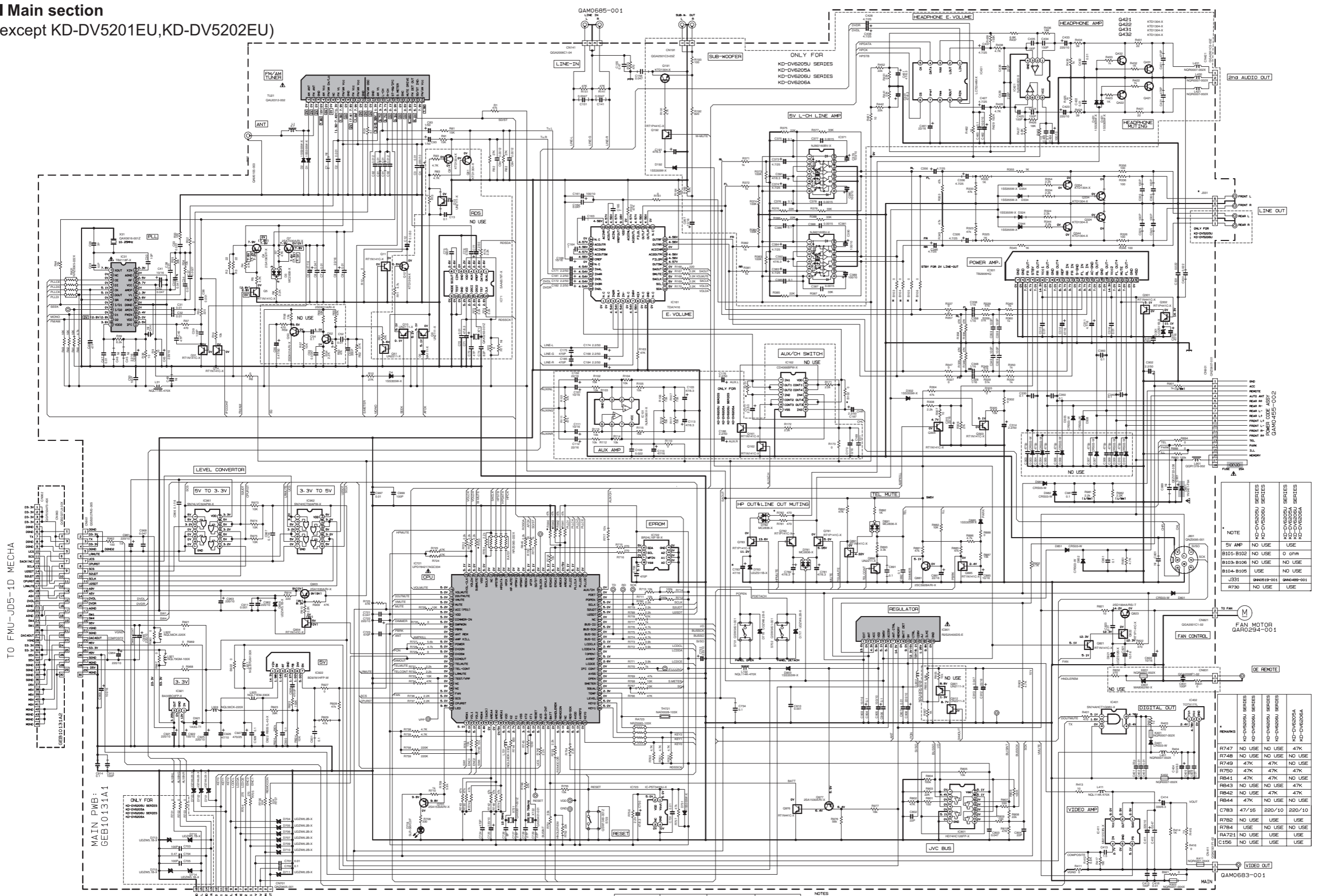

NOTE

Part No.	Part Name	Series	Use
5V AMP	NO USE	NO USE	USE
B101-B102	NO USE	NO USE	0 ohm
B103-B106	NO USE	NO USE	NO USE
B104-B105	USE	NO USE	NO USE
J331	GN60519-001	GN60-489-001	USE
R730	NO USE	NO USE	USE

REMARKS

Part No.	Series	Series	Series	Series
R747	NO USE	NO USE	47K	
R748	NO USE	NO USE	NO USE	
R749	47K	47K	NO USE	
R750	47K	47K	47K	
R841	47K	47K	NO USE	
R843	NO USE	NO USE	47K	
R842	NO USE	47K	NO USE	
R844	47K	NO USE	47K	
C783	47/16	220/10	220/10	
R782	NO USE	USE	USE	
R784	USE	NO USE	NO USE	
RA721	NO USE	USE	USE	
C156	NO USE	USE	USE	

⚠ Parts are safety assurance parts.
When replacing those parts make
sure to use the specified one.

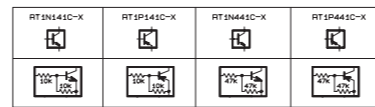

- NOTES
- VOLTAGES ARE DC-MEASURED WITH A DIGITAL VOLT METER WITHOUT INPUT SIGNAL. CONDITION: DVD MODE () FM MODE () AM MODE.
 - UNLESS OTHERWISE SPECIFIED, ALL RESISTORS ARE 1/10W ±5% METAL GLAZE RESISTOR. ALL CAPACITORS ARE 50V OR 25V CERAMIC CAPACITOR. ALL RESISTANCE VALUES ARE IN OHM. ALL CAPACITANCE VALUES ARE IN μF (pF). ALL CAPACITORS ARE SHOWN IN THE FORM OF CAPACITANCE/(RATED VOLTAGE/V). F — FILM CAPACITOR.
 - NI STANDS FOR NOT MOUNTED PARTS.

■ LCD and Key control section
(except KD-DV5201EU, KD-DV5202EU)

SW PWB : GEB10134A

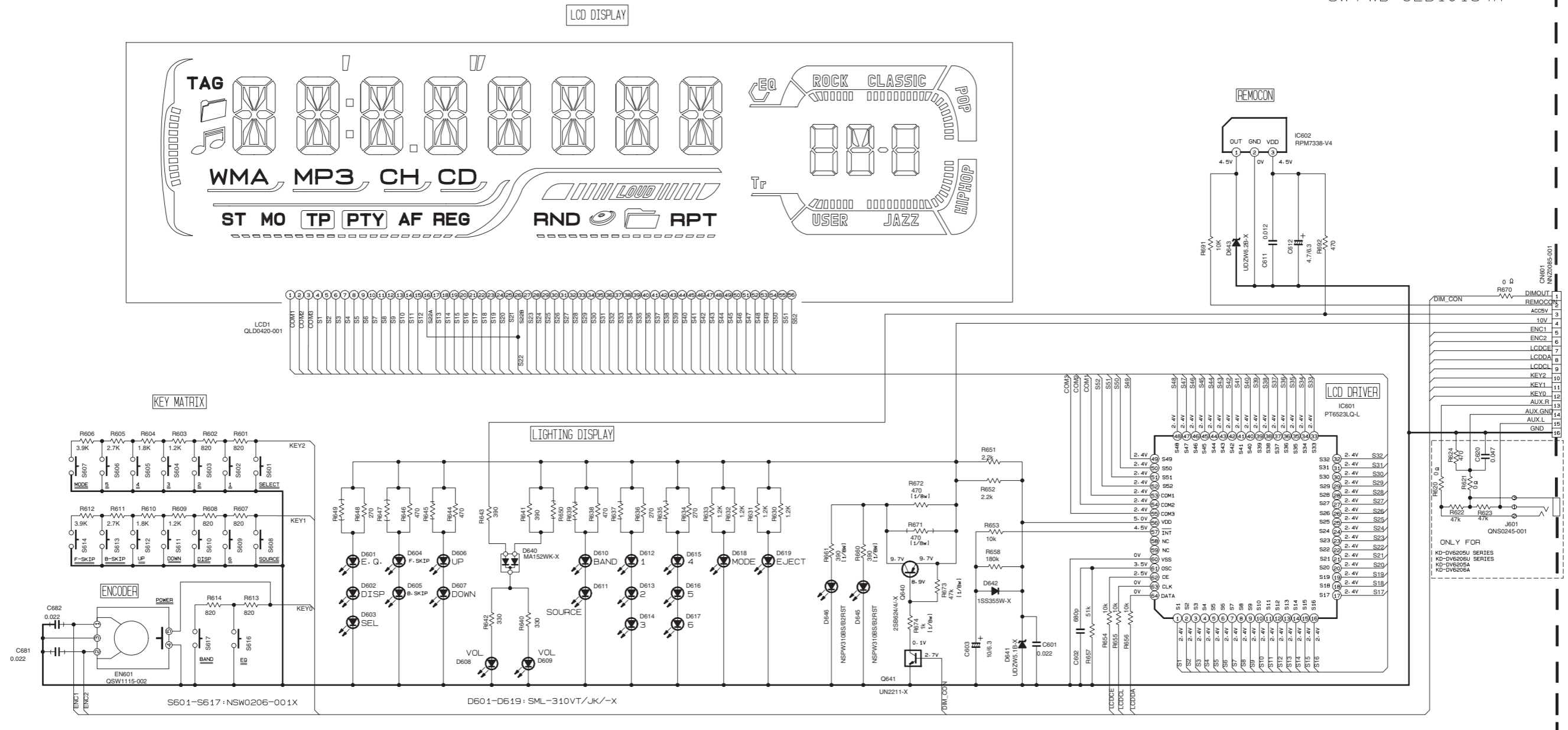

* REMARKS	KD-DV5205U SERIES KD-DV5205A SERIES KD-DV5206U SERIES KD-DV5206A SERIES	KD-DV6205U SERIES KD-DV6205A SERIES KD-DV6206U SERIES KD-DV6206A SERIES
R630	1.2K	1K
R631 R633	1.2K	-
R632	1.2K	820
R634 R636 R648	270	330
R641	390	120
R643	390	200

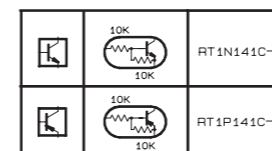

NOTES

- VOLTAGES ARE DC-MEASURED WITH A DIGITAL VOLT METER WITHOUT INPUT SIGNAL.
- UNLESS OTHERWISE SPECIFIED, ALL RESISTORS ARE 1/16W METAL GLAZE RESISTORS. ALL CAPACITORS ARE 50V OR 25V CERAMIC CAPACITOR. ALL RESISTANCE VALUES ARE IN OHM. ALL CAPACITANCE VALUES ARE IN uF(P=pF) ALL E-CAPACITORS ARE SHOWN IN THE FORM OF CAPACITANCE(uF)/RATED VOLTAGE(V) T --- TANTALUM CAPACITOR.
- COMPONENTS IN () INDICATE NOT USE.

Printed circuit boards

■ **Main board** Lead free solder used in the board (material : Sn-Ag-Cu, melting point : 219 Centigrade)

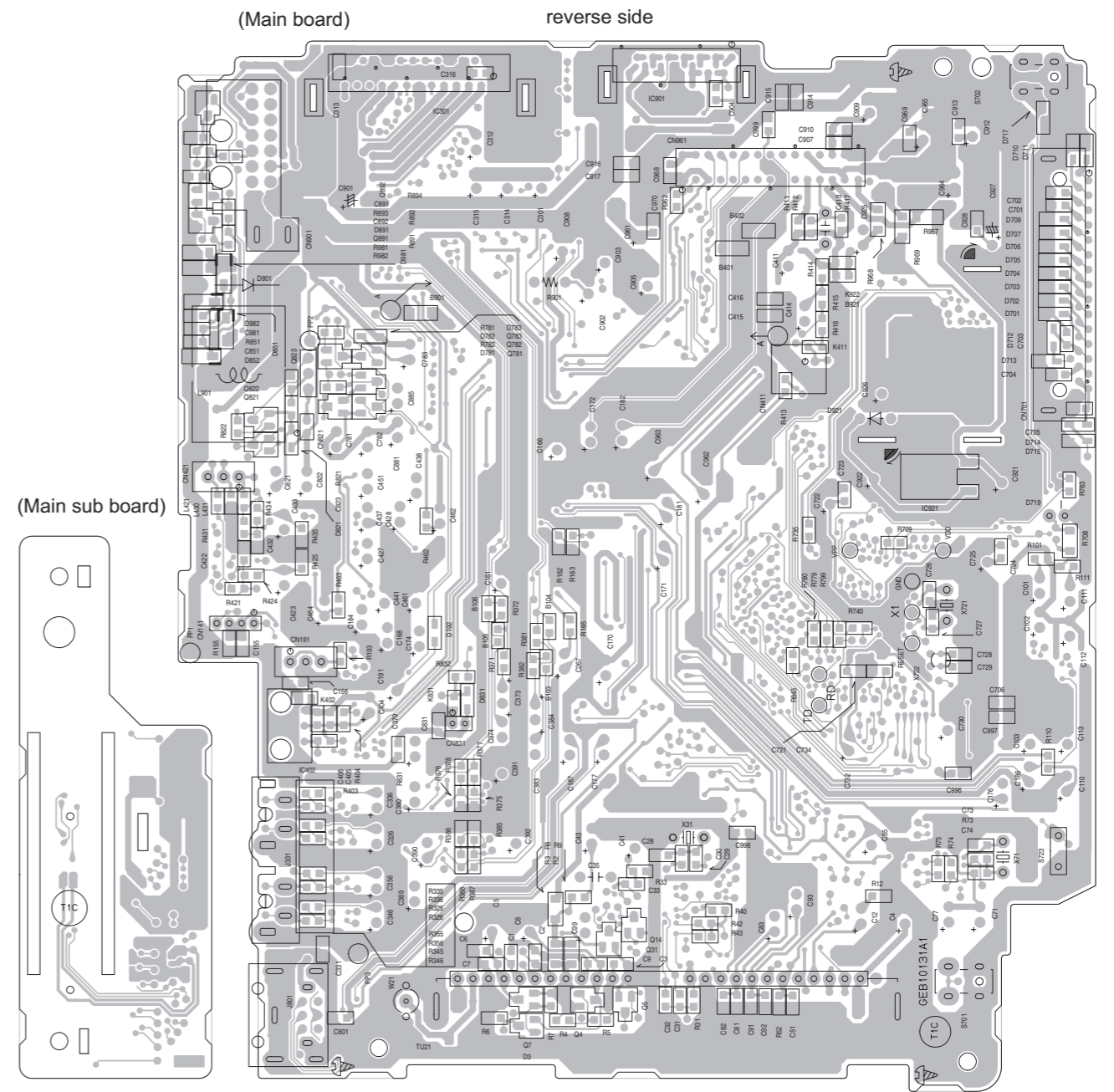
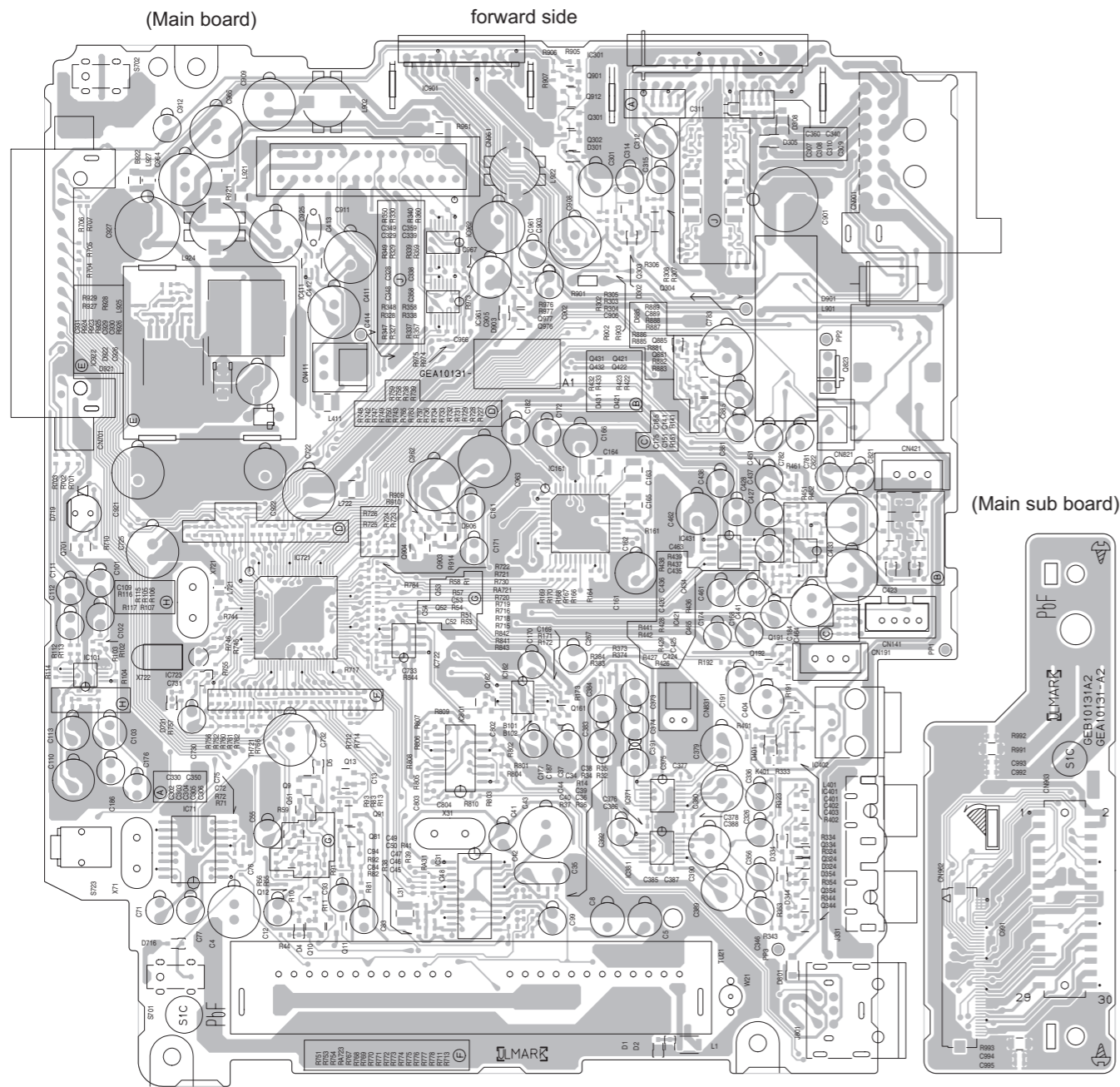

■ **Switch board** Lead free solder used in the board (material : Sn-Ag-Cu, melting point : 219 Centigrade)

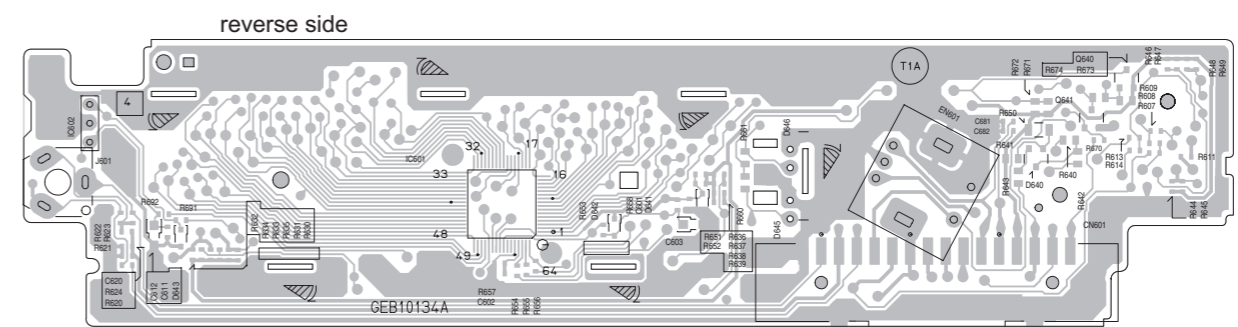
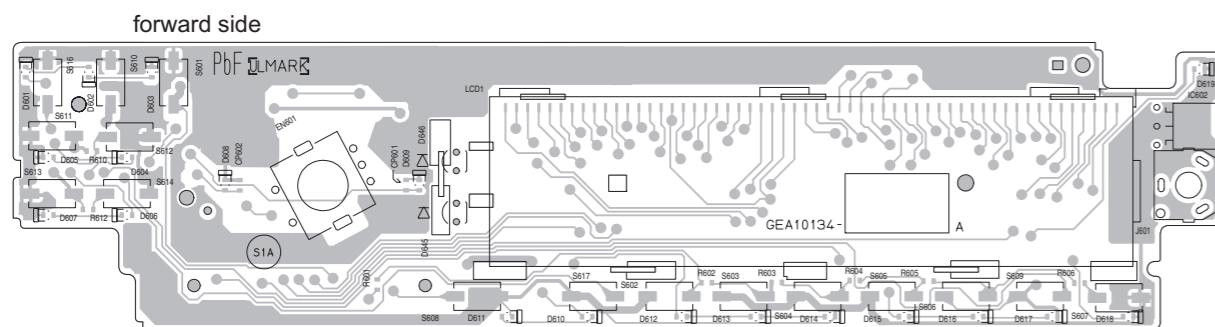

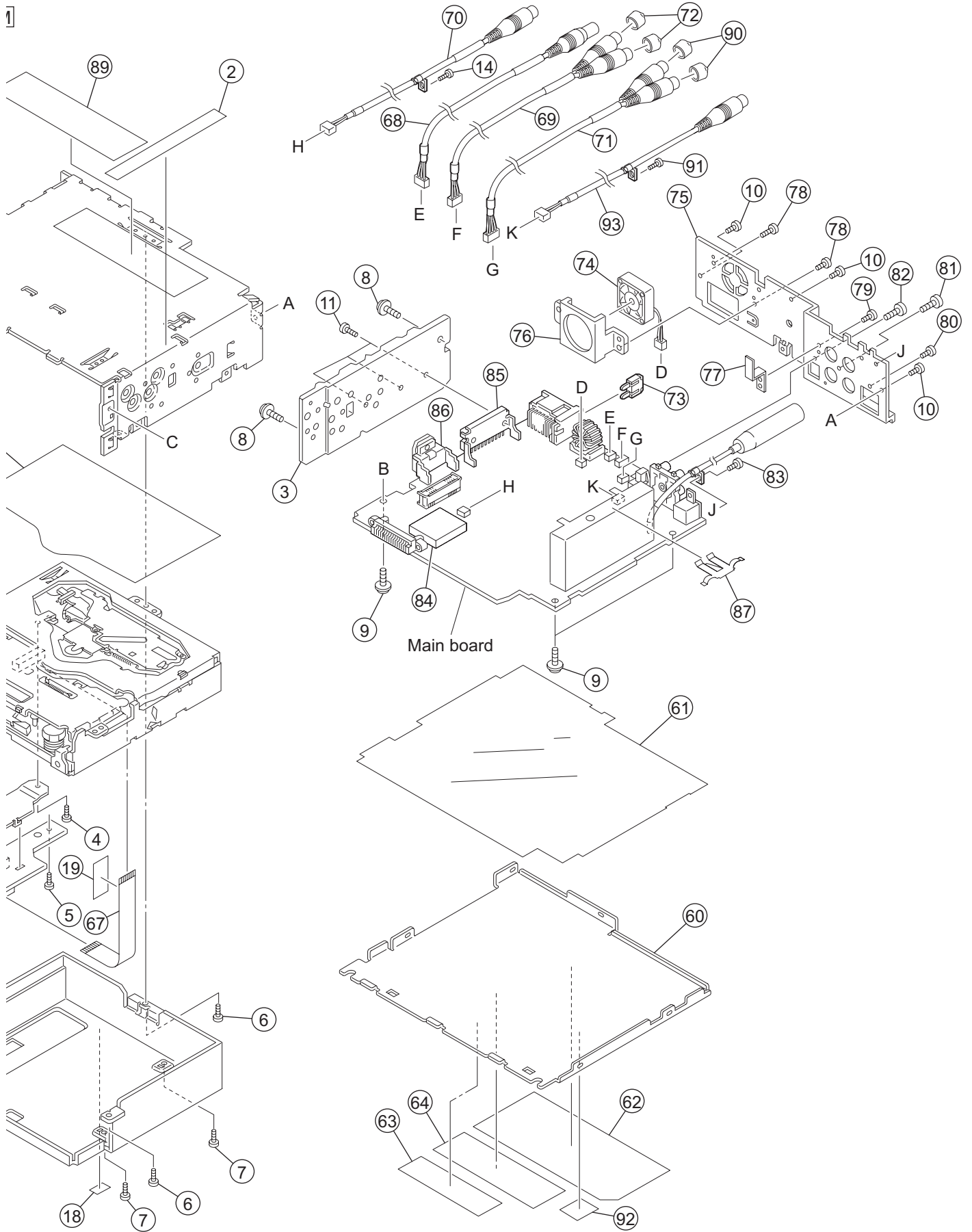

General Assembly

Block No. [M][1][M][M]

△ Symbol No.	Part No.	Part Name	Description	Local
1	LV10774-008A	TOP CHASSIS		
2	LV40848-044A	SPACER(P)		
3	LV34061-001A	SIDE HEAT SINK		
4	QYSDST2003ZA	TAP SCREW	M2 x 3mm(x2)	
5	QYSDST2606ZA	TAP SCREW	M2.6 x 6mm(x2)	
6	QYSDST2604ZA	TAP SCREW	M2.6 x 4mm(x3)	
7	QYSDST2604ZA	TAP SCREW	M2.6 x 4mm(x2)	
8	GE40235-001A	SCREW	(x2)	
9	GE40235-004A	SCREW	(x3)	
10	QYSDST2604ZA	TAP SCREW	M2.6 x 4mm(x3)	
11	LV41200-005A	SCREW	(x3)	
12	QYSDSF2006ZA	TAP SCREW	M2 x 6mm(x2)	
13	QYSDST2004ZA	TAP SCREW	M2 x 4mm(x2)	
14	QYSDST2604ZA	TAP SCREW	M2.6 x 4mm	
15	LV34460-001A	INSULATOR		
16	GE40255-001A	SUPPORT BRACKET		
17	GE20180-001A	DUST COVER		
18	GE40218-034A	SHEET		
19	GE40278-001A	SHEET		
20	LV34065-004A	F.CHASSIS ASSY		
21	FSYH4036-098	SHEET		
22	GE30827-002A	OPEN LEVER		
23	GE30824-002A	LOCK LEVER(O.L)		
24	GE31245-002A	RELEASE LEVER		
25	GE30829-001A	LOCK LEVER(TOP)		
26	GE31607-001A	LOCK LEVER(L)		
27	GE31608-001A	LOCK LEVER(R)		
28	GE40154-001A	GEAR		
29	QZW0108-002	OIL DAMPER		
30	GE40153-001A	T.SPRING		
31	GE40157-001A	T.SPRING		
32	VKW5264-005	T.SPRING		
33	FSKW4012-002	T.SPRING		
34	LV43392-001A	T.SPRING		
35	GE40155-001A	T.SPRING		
36	QYSDSF2006ZA	TAP SCREW	M2 x 6mm	
37	GE40156-001A	BLIND		
38	LV40848-042A	SPACER(P)		
39	LV40848-043A	SPACER(P)		
40	GE31590-035A	FRONT PANEL ASSY		DV5201EU
40	GE31590-036A	FRONT PANEL ASSY		DV5202EU
40	GE31590-037A	FRONT PANEL ASSY		DV5205U,DV5205UT
40	GE31590-038A	FRONT PANEL ASSY		DV5206U,DV5206UT
40	GE31590-039A	FRONT PANEL ASSY		DV6205A,DV6205U,DV6205UT
40	GE31590-040A	FRONT PANEL ASSY		DV6206A,DV6206U,DV6206UT
41	GE31591-033A	FINDER ASSY		DV5201EU
41	GE31591-034A	FINDER ASSY		DV5202EU
41	GE31592-014A	FINDER ASSY		DV5205U,DV5205UT
41	GE31592-015A	FINDER ASSY		DV5206U,DV5206UT
41	GE31591-035A	FINDER ASSY		DV6205A,DV6205U,DV6205UT
41	GE31591-036A	FINDER ASSY		DV6206A,DV6206U,DV6206UT
42	GE40298-001A	VOLUME KNOB ASS		DV5201EU,DV5205U,DV5205UT,DV6205A,DV6205U,DV6205UT
42	GE40298-002A	VOLUME KNOB ASS		DV5202EU,DV5206U,DV5206UT,DV6206A,DV6206U,DV6206UT
43	GE31599-002A	RIM LENS		DV5201EU,DV5202EU
43	GE31599-001A	RIM LENS		DV5205U,DV5205UT,DV5206U,DV5206UT, DV6205A,DV6205U,DV6205UT,DV6206A,DV6206U,DV6206UT
44	GE31593-006A	D.FUNC BTN		DV5201EU
44	GE31593-013A	D.FUNC BTN		DV5202EU
44	GE31593-008A	D.FUNC BTN		DV5205U,DV5205UT,DV6205A,DV6205U,DV6205UT
44	GE31593-001A	D.FUNC BTN		DV5206U,DV5206UT,DV6206A,DV6206U,DV6206UT
45	GE20175-009A	PRESET BUTTON		DV5201EU
45	GE20175-007A	PRESET BUTTON		DV5202EU,DV5206U,DV5206UT,DV6206A,DV6206U,DV6206UT
45	GE20175-010A	PRESET BUTTON		DV5205U,DV5205UT,DV6205A,DV6205U,DV6205UT
46	GE31594-004A	UP/DOWN BTN		DV5201EU
46	GE31594-002A	UP/DOWN BTN		DV5202EU,DV5206U,DV5206UT,DV6206A,DV6206U,DV6206UT
46	GE31594-001A	UP/DOWN BTN		DV5205U,DV5205UT,DV6205A,DV6205U,DV6205UT
47	GE31595-004A	SEARCH BTN		DV5201EU
47	GE31595-002A	SEARCH BTN		DV5202EU,DV5206U,DV5206UT,DV6206A,DV6206U,DV6206UT
47	GE31595-001A	SEARCH BTN		DV5205U,DV5205UT,DV6205A,DV6205U,DV6205UT
48	VKZ4777-010	MINI SCREW		
49	GE31601-003A	EJECT BUTTON		DV5201EU
49	GE31601-002A	EJECT BUTTON		DV5202EU,DV5206U,DV5206UT,DV6206A,DV6206U,DV6206UT
49	GE31601-005A	EJECT BUTTON		DV5205U,DV5205UT,DV6205A,DV6205U,DV6205UT
50	GE31598-001A	RIM COVER		DV5201EU,DV5205U,DV5205UT,DV6205A,DV6205U,DV6205UT

△	Symbol No.	Part No.	Part Name	Description	Local
	50	GE31598-002A	RIM COVER		DV5202EU,DV5206U,DV5206UT,DV6206A,DV6206U,DV6206UT
	51	FSKW3002-012	COMP.SPRING		
	52	GE40202-012A	COMPRESSION SPRING		
	53	GE10107-002A	REAR COVER		
	54	VKZ4777-010	MINI SCREW	(x4)	
	55	GE31603-001A	LCD CASE		
	56	GE31604-001A	LCD LENS		
	57	GE31605-001A	LENS CASE		
	58	GE40251-002A	LIGHTING SHEET		
	59	GE40218-032A	SHEET		
	60	LV34058-002A	BOTTOM COVER		
	61	GE31663-001A	INSULATOR		
	62	GE32196-001A	NAME PLATE		DV5201EU
	62	GE32199-001A	NAME PLATE		DV5202EU
	62	GE32210-001A	NAME PLATE		DV5205U,DV5205UT
	62	GE32213-001A	NAME PLATE		DV5206U,DV5206UT
	62	GE32202-001A	NAME PLATE		DV6205A,DV6205U,DV6205UT
	62	GE32206-001A	NAME PLATE		DV6206A,DV6206U,DV6206UT
	63	LV41843-002A	LASER CAUTION		
	64	GE31683-010A	LABEL (DVD)		DV5201EU,DV5202EU
	64	GE31683-011A	LABEL (DVD)		DV5205U,DV5205UT,DV5206U,DV5206UT, DV6205U,DV6205UT,DV6206U,DV6206UT
	64	GE31683-012A	LABEL (DVD)		DV6205A,DV6206A
	65	QLD0420-001	LCD MODULE		
	66	QNZ0772-001	RUBBER CONN		
	67	QUQP05-4510BB-E	FFC WIRE	45pin 10cm	
	68	QAM0680-001	HP CABLE		DV5201EU,DV5202EU,DV6205A,DV6205U,DV6205UT, DV6206A,DV6206U,DV6206UT
	69	QAM0685-001	LINE IN CABLE		
	70	QAM0683-001	COMPOSITE CABLE		
	71	QAM0684-001	SUBWOOFER CABLE		DV5201EU,DV5202EU,DV6205A,DV6205U,DV6205UT, DV6206A,DV6206U,DV6206UT
	72	VYTA500-001	PIN CAP	(x2)	
△	73	QMFZ039-150-T	FUSE	15A	
	74	QAR0294-001	FAN MOTOR		
	75	GE31609-021A	REAR BRACKET		DV5201EU,DV5202EU,DV6205A,DV6205U,DV6205UT, DV6206A,DV6206U,DV6206UT
	75	GE31609-023A	REAR BRACKET		DV5205U,DV5205UT,DV5206U,DV5206UT
	76	GE40252-002A	FAN BRACKET		
	77	GE40253-001A	WIRE HOLDER		
	78	QYSDST2604ZA	TAP SCREW	M2.6 x 4mm(x2)	
	79	QYSDST2604ZA	TAP SCREW	M2.6 x 4mm	
	80	QYSDST2606ZA	TAP SCREW	M2.6 x 6mm	
	81	QYSDSF2606ZA	TAP SCREW	M2.6 x 6mm	
	82	QYSDSF2606ZA	TAP SCREW	M2.6 x 6mm	
	83	QYSDST2604ZA	TAP SCREW	M2.6 x 4mm	
	84	GE40270-001A	SHIELD COVER		
	85	LV43349-002A	POWER IC BKT		
	86	LV43373-002A	REGULATOR BKT		
	87	VMA4652-001SS	EARTH PLATE		
	88	GE30854-001A	LED HOLDER		
	89	GE31574-037A	UT LABEL		DV5205UT
	89	GE31574-038A	UT LABEL		DV5206UT
	89	GE31574-039A	UT LABEL		DV6205UT
	89	GE31574-040A	UT LABEL		DV6206UT
	90	VYTA500-001	PIN CAP	(x2)	DV5201EU,DV5202EU,DV6205A,DV6205U,DV6205UT, DV6206A,DV6206U,DV6206UT
	91	QYSDST2604ZA	TAP SCREW	M2.6 x 4mm	DV5201EU,DV5202EU
	92	LV44385-001A	RECYCLE LABEL		DV5201EU,DV5202EU
	93	QAM0686-001	STEERING REMOTE		DV5201EU,DV5202EU

DVD mechanism assembly and parts list

FMU-JD5-2D

Block No. M J M M

Grease

- ★ = JVS-1003
- = MOBIL-1
- ▲ = JVG-31N
- = JC-803B
- = 1401C
- ◎ = FG-87HS

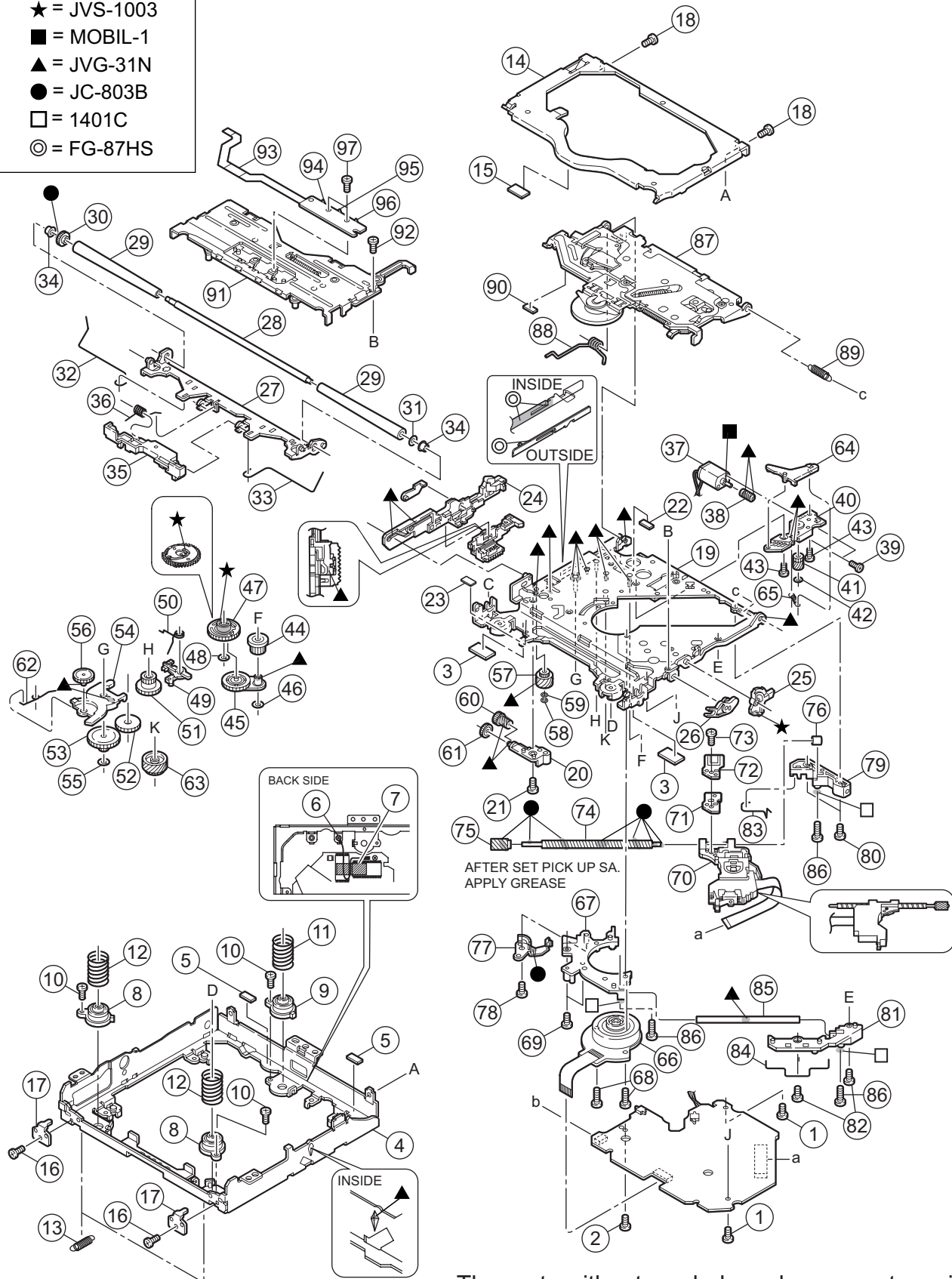

The parts without symbol number are not service.

DVD mechanism

Block No. [M][J][M][M]

△	Symbol No.	Part No.	Part Name	Description	Local
	1	VKZ4539-056	MINI SCREW	(x2)	
	2	QYSPSFT2040ZA	TAP SCREW	M2 x 4mm	
	3	LV43481-001A	COOLING RUBBER	(x2)	
	4	LV10674-001A	CHASSIS FRAME		
	5	LV30225-0J6A	SPACER	(x2)	
	6	VKZ4539-056	MINI SCREW		
	7	VYSA1R4-056	SPACER		
	8	LV35272-001A	DAMPER(F)	(x2)	
	9	LV35273-001A	DAMPER(R)		
	10	QYSDST2005ZA	TAP SCREW	M2 x 5mm(x3)	
	11	LV43039-001A	DAMPER SP.(R)		
	12	LV43849-001A	DAMPER SP(F2)	(x2)	
	13	LV43041-001A	FLOATING SPRING	(x2)	
	14	LV10675-001A	TOP COVER		
	15	LV30225-0J5A	SPACER		
	16	VKZ4539-056	MINI SCREW	(x2)	
	17	LV33669-001A	STOPPER	(x2)	
	18	VKZ4539-056	MINI SCREW	(x2)	
	19	LV21297-004A	CHAS. BASE ASSY		
	20	LV33608-002A	GEAR HOLDER		
	21	VKZ4539-056	MINI SCREW		
	22	LV43561-002A	ABSORBER		
	23	LV30225-0J5A	SPACER		
	24	LV36831-001A	SLIDE CAM ASSY2		
	25	LV33610-002A	FLOATING ARM		
	26	LV33611-001A	CONNECT ARM		
	27	LV33678-003A	LOADING A. ASSY		
	28	LV43049-001A	LOADING SHAFT		
	29	LV43052-003A	ROLLER	(x2)	
	30	LV33612-001A	LOADING GEAR		
	31	QYWFM124013	WASHER	4mm/1.2mm x 0.13mm	
	32	LV43053-002A	ROD(L)		
	33	LV43054-003A	ROD(R)		
	34	LV43001-001A	COLLAR	(x2)	
	35	LV21285-003A	PROTECTOR		
	36	LV43055-001A	PROTECTOR SP.		
	37	QAR0373-001	MOTOR		
	38	LV43002-002A	WORM GEAR		
	39	QYSPSPT2025MA	SCREW	M2 x 2.5mm(x2)	
	40	LV33679-001A	MOTOR H. ASSY		
	41	LV33614-003A	WORM WHEEL		
	42	QYWDL1230250	SLIT WASHER	3mm/1.2mm x 0.25mm	
	43	VKZ4539-056	MINI SCREW	(x2)	
	44	LV33615-001A	GEAR 2		
	45	LV43057-004A	IDLER ARM ASSY		
	46	QYWDL1635252	SLIT WASHER	3.5mm/1.6mm x 0.25mm	
	47	LV21286-001A	CONTROL CAM		
	48	QYWDL1230196	SLIT WASHER	3mm/1.2mm x 0.19mm	
	49	LV33616-002A	LOAD.LOCK LEVER		
	50	LV43060-001A	CAM SPRING		
	51	LV43005-001A	GEAR 4		
	52	LV43006-002A	GEAR 5		
	53	LV33617-002A	GEAR 6		
	54	LV33618-002A	LOADING G. ARM		
	55	QYWDL1635252	SLIT WASHER	3.5mm/1.6mm x 0.25mm	
	56	LV43007-002A	GEAR 7		
	57	LV33619-002A	GEAR 8		
	58	LV42132-001A	E RING		
	59	QYWFM215013	WASHER	5mm/2.1mm x 0.13mm	
	60	LV33620-001A	GEAR 9		
	61	LV43008-001A	GEAR10		
	62	LV43061-001A	LOAD SPRING		
	63	LV33621-001A	FEED GEAR		
	64	LV33622-002A	TRIGGER ARM		
	65	LV43062-001A	FEED TRI.SPRING		
	66	QAR0240-002	SPINDLE MOTOR		
	67	LV21287-002A	SPINDLE BASE		
	68	LV44169-001A	SPECIAL SCREW	(x2)	
	69	VKZ4539-056	MINI SCREW	(x2)	
	70	QAL0742-001	DVD PICK UP		
	71	LV34583-002A	CD RACK PLATE		
	72	LV34579-001A	CD RACK SPRING		
	73	LV43903-002A	MINI TAP SCREW		
	74	LV43037-001A	LEAD SCREW		

Symbol No.	Part No.	Part Name	Description	Local
75	LV43010-001A	L.S.GEAR		
76	LV43063-001A	L.S.COLLAR		
77	LV43011-001A	THRUST SPRING		
78	QYSPSFT2040ZA	TAP SCREW	M2 x 4mm	
79	LV33624-001A	HOLDER(M)		
80	VKZ4539-056	MINI SCREW	(x2)	
81	LV22130-001A	HOLDER(S) 2		
82	VKZ4539-056	MINI SCREW	(x2)	
83	LV43064-001A	ROD(M)		
84	LV43065-001A	ROD(S)		
85	LV43066-001A	SUB SHAFT		
86	VKZ4730-002	SPECIAL SCREW	(x3)	
87	LV21298-007A	CLAMPER UNIT		
88	LV43070-001A	CLAMPER SPRING		
89	LV43355-001A	CLAMPER2 SPRING		
90	LV30225-0J6A	SPACER		
91	LV22185-001A	FRONT UNIT (C)		
92	VKZ4539-056	MINI SCREW		
93	LVB30012-002A	SW FPC		
94	NSW0187-001	SWITCH	S1	
95	NSW0187-001	SWITCH	S1	
96	NSW0187-001	SWITCH	S1	
97	VKZ4539-055	MINI SCREW	(x2)	

Electrical parts list

Main board

(KD-DV5201EU,KD-DV5202EU)

Block No. [0][1]

△ Symbol No.	Part No.	Part Name	Description	Local
△ IC31	TB2118F-X	PLL IC		
IC71	SAA6579T-X	IC		
IC101	NJM4565V-X	IC		
IC161	TDA7416	IC		
IC162	CD4066BPW-X	IC		
IC301	TB2906HQ	IC		
IC371	NJM2160BV-X	IC		
IC381	NJM2160BV-X	IC		
IC401	SN74AHCT1G08V-X	IC		
IC402	TOTX177L	OPTICAL JACK		
IC411	MM1510XN-X	IC		
IC421	NJM4580V-X	IC		
IC431	LC75344M-X	IC		
△ IC721	UPD784217AGC329	IC		
IC722	BR24L32F-W-X	IC(DIGITAL)		
IC723	S-80833CNNB-G-W	IC		
IC801	HD74HC126FP-X	IC		
△ IC901	R2S25400DS-E	IC		
IC921	BA33BCOFF-X	IC		
IC922	BD9781HFP-W	IC		
IC961	SN74LVC32APW-X	IC		
IC962	SN74HCT32APW-X	IC		
Q4	2SA1365/F-X	TRANSISTOR		
Q5	RT1N141C-X	DIGI TRANSISTOR		
Q7	2SA1530A/R-X	TRANSISTOR		
Q9	RT1P141C-X	DIGI TRANSISTOR		
Q10	RT1P141C-X	DIGI TRANSISTOR		
Q11	RT1N141C-X	DIGI TRANSISTOR		
Q12	KTD1304-X	TRANSISTOR		
Q14	RT1N141C-X	DIGI TRANSISTOR		
Q31	RT1N141C-X	DIGI TRANSISTOR		
Q51	RT1N141C-X	DIGI TRANSISTOR		
Q52	2SC3928A/R-X	TRANSISTOR		
Q53	2SC3928A/R-X	TRANSISTOR		
Q81	KTD1304-X	TRANSISTOR		
Q91	KTD1304-X	TRANSISTOR		
Q161	RT1N141C-X	DIGI TRANSISTOR		
Q162	RT1N141C-X	DIGI TRANSISTOR		
Q191	KTD1304-X	TRANSISTOR		
Q192	RT1P441C-X	DIGI TRANSISTOR		
Q301	RT1N441C-X	TRANSISTOR		
Q302	RT1P441C-X	DIGI TRANSISTOR		
Q303	RT1N141C-X	DIGI TRANSISTOR		
Q304	RT1N141C-X	DIGI TRANSISTOR		
Q324	KTD1304-X	TRANSISTOR		
Q334	KTD1304-X	TRANSISTOR		
Q344	KTD1304-X	TRANSISTOR		
Q354	KTD1304-X	TRANSISTOR		
Q421	KTD1304-X	TRANSISTOR		
Q422	KTD1304-X	TRANSISTOR		
Q431	KTD1304-X	TRANSISTOR		
Q432	KTD1304-X	TRANSISTOR		
Q701	2SA1530A/R-X	TRANSISTOR		
Q781	RT1P141C-X	DIGI TRANSISTOR		
Q782	RT1P141C-X	DIGI TRANSISTOR		
Q783	RT1P141C-X	DIGI TRANSISTOR		
Q821	RT1N141C-X	DIGI TRANSISTOR		
Q822	RT1P141C-X	DIGI TRANSISTOR		
Q823	2SD1994A/RS-T	TRANSISTOR		
Q881	2SC3928A/R-X	TRANSISTOR		
Q885	RT1N141C-X	DIGI TRANSISTOR		
Q891	RT1N141C-X	DIGI TRANSISTOR		
Q903	2SA1530A/R-X	TRANSISTOR		
Q904	RT1N141C-X	DIGI TRANSISTOR		
Q976	RT1N441C-X	TRANSISTOR		
Q977	2SA1530A/R-X	TRANSISTOR		
D1	1SS355W-X	DIODE		
D2	1SS355W-X	DIODE		

△ Symbol No.	Part No.	Part Name	Description	Local
D3	MC2838-X	DIODE		
D5	1SS355W-X	DIODE		
D192	1SS355W-X	DIODE		
D301	UDZS11B-X	Z DIODE		
D302	1SS355W-X	DIODE		
D305	CRS03-W	SB DIODE		
D308	CRS03-W	SB DIODE		
D324	1SS355W-X	DIODE		
D334	1SS355W-X	DIODE		
D344	1SS355W-X	DIODE		
D354	1SS355W-X	DIODE		
D401	CRS03-W	SB DIODE		
D421	1SS355W-X	DIODE		
D431	1SS355W-X	DIODE		
D701	UDZW6.2B-X	Z DIODE		
D702	UDZW6.2B-X	Z DIODE		
D703	UDZW6.2B-X	Z DIODE		
D704	UDZW6.2B-X	Z DIODE		
D705	UDZW6.2B-X	Z DIODE		
D706	UDZW6.2B-X	Z DIODE		
D707	UDZW6.2B-X	Z DIODE		
D709	UDZW6.2B-X	Z DIODE		
D710	UDZW6.2B-X	Z DIODE		
D711	UDZW6.2B-X	Z DIODE		
D712	UDZW5.1B-X	SB DIODE		
D713	UDZW5.1B-X	SB DIODE		
D714	UDZW5.1B-X	SB DIODE		
D715	UDZW5.1B-X	SB DIODE		
D716	UDZW6.2B-X	Z DIODE		
D717	UDZW6.2B-X	Z DIODE		
D719	SLR-56VC3F	DIODE C.M		
D731	1SS355W-X	DIODE		
D781	MC2836-X	DIODE		
D782	MC2836-X	DIODE		
D783	UDZS9.1B-X	Z DIODE		
D801	CRS03-W	SB DIODE		
D821	UDZS12B-X	Z DIODE		
D831	UDZW6.2B-X	Z DIODE		
D885	1SS355W-X	DIODE		
D891	MC2836-X	DIODE		
△ D901	1N5401-F64	SI DIODE		
D903	1SS355W-X	DIODE		
D906	UDZW5.1B-X	SB DIODE		
D921	1A3G-T1	SI DIODE		
D922	RB051L-40-X	SB DIODE		
D981	CRS03-W	SB DIODE		
D982	CRS03-W	SB DIODE		
C2	NCB31HK-102X	C CAPACITOR	1000pF 50V K	
C3	NCB31HK-103X	C CAPACITOR	0.01uF 50V K	
C4	QEKJ1AM-227Z	E CAPACITOR	220uF 10V M	
C5	QEKJ1CM-476Z	E CAPACITOR	47uF 16V M	
C6	NCB31EK-473X	C CAPACITOR	0.047uF 25V K	
C7	NCB31HK-103X	C CAPACITOR	0.01uF 50V K	
C8	QEKJ1CM-226Z	E CAPACITOR	22uF 16V M	
C9	NCB31HK-103X	C CAPACITOR	0.01uF 50V K	
C12	QEKJ1HM-104Z	E CAPACITOR	0.1uF 50V M	
C13	NCF31CZ-104X	C CAPACITOR	0.1uF 16V Z	
C28	NCS31HJ-7R0X	C CAPACITOR	7pF 50V J	
C29	NDC31HJ-100X	C CAPACITOR	10pF 50V J	
C30	NDC31HJ-100X	C CAPACITOR	10pF 50V J	
C31	NCB31HK-103X	C CAPACITOR	0.01uF 50V K	
C32	NCB31HK-103X	C CAPACITOR	0.01uF 50V K	
C33	NCB31HK-102X	C CAPACITOR	1000pF 50V K	
C34	NCB31HK-103X	C CAPACITOR	0.01uF 50V K	
C35	QFV61HJ-473Z	MF CAPACITOR	0.047uF 50V J	
C36	NCB31HK-102X	C CAPACITOR	1000pF 50V K	
C37	NCB31HK-272X	C CAPACITOR	2700pF 50V K	
C38	NCB31HK-103X	C CAPACITOR	0.01uF 50V K	
C39	NCS31HJ-101X	C CAPACITOR	100pF 50V J	
C40	NDC31HJ-470X	C CAPACITOR	47pF 50V J	
C41	QEKJ1CM-106Z	E CAPACITOR	10uF 16V M	
C42	NCB31EK-473X	C CAPACITOR	0.047uF 25V K	
C43	QEKJ1AM-227Z	E CAPACITOR	220uF 10V M	
C47	NCB31HK-103X	C CAPACITOR	0.01uF 50V K	
C48	NCS31HJ-470X	C CAPACITOR	47pF 50V J	

△ Symbol No.	Part No.	Part Name	Description	Local	△ Symbol No.	Part No.	Part Name	Description	Local
C50	NCS31HJ-101X	C CAPACITOR	100pF 50V J		C375	NCB31EK-104X	C CAPACITOR	0.1uF 25V K	
C51	NCS31HJ-331X	C CAPACITOR	330pF 50V J		C376	NCB31EK-104X	C CAPACITOR	0.1uF 25V K	
C52	NCB31HK-103X	C CAPACITOR	0.01uF 50V K		C377	NCB31HK-152X	C CAPACITOR	1500pF 50V K	
C53	NCB31HK-472X	C CAPACITOR	4700pF 50V K		C378	NCB31HK-152X	C CAPACITOR	1500pF 50V K	
C54	NCB31CK-104X	C CAPACITOR	0.1uF 16V K		C379	QEKJ1AM-107Z	E CAPACITOR	100uF 10V M	
C55	QEKJ1HM-474Z	E CAPACITOR	0.47uF 50V M		C380	QEKJ1AM-107Z	E CAPACITOR	100uF 10V M	
C71	QEKJ0JM-476Z	E CAPACITOR	47uF 6.3V M		C383	QEKJ1EM-475Z	E CAPACITOR	4.7uF 25V M	
C72	NCB31HK-103X	C CAPACITOR	0.01uF 50V K		C384	QEKJ1EM-475Z	E CAPACITOR	4.7uF 25V M	
C73	NCS31HJ-470X	C CAPACITOR	47pF 50V J		C385	NCB31EK-104X	C CAPACITOR	0.1uF 25V K	
C74	NCS31HJ-820X	C CAPACITOR	82pF 50V J		C386	NCB31EK-104X	C CAPACITOR	0.1uF 25V K	
C75	NCS31HJ-561X	C CAPACITOR	560pF 50V J		C387	NCB31HK-152X	C CAPACITOR	1500pF 50V K	
C76	NCB31HK-223X	C CAPACITOR	0.022uF 50V K		C388	NCB31HK-152X	C CAPACITOR	1500pF 50V K	
C77	QEKJ1HM-225Z	E CAPACITOR	2.2uF 50V M		C389	QEKJ1AM-107Z	E CAPACITOR	100uF 10V M	
C81	NCB31HK-123X	C CAPACITOR	0.012uF 50V K		C390	QEKJ1AM-107Z	E CAPACITOR	100uF 10V M	
C82	NCB31HK-102X	C CAPACITOR	1000pF 50V K		C391	QEKJ0JM-476Z	E CAPACITOR	47uF 6.3V M	
C83	QTE1H57-105Z	E CAPACITOR	1uF 50V		C392	QEKJ0JM-476Z	E CAPACITOR	47uF 6.3V M	
C84	NCB31HK-122X	C CAPACITOR	1200pF 50V K		C401	NCS31HJ-220X	C CAPACITOR	22pF 50V J	
C91	NCB31HK-123X	C CAPACITOR	0.012uF 50V K		C402	NCB31HK-103X	C CAPACITOR	0.01uF 50V K	
C92	NCB31HK-102X	C CAPACITOR	1000pF 50V K		C403	NCB31HK-103X	C CAPACITOR	0.01uF 50V K	
C93	QTE1H57-105Z	E CAPACITOR	1uF 50V		C404	QEKJ0JM-107Z	E CAPACITOR	100uF 6.3V M	
C94	NCB31HK-122X	C CAPACITOR	1200pF 50V K		C405	NCS31HJ-220X	C CAPACITOR	22pF 50V J	
C99	QEKJ1CM-226Z	E CAPACITOR	22uF 16V M		C406	NCB31HK-103X	C CAPACITOR	0.01uF 50V K	
C101	QEKJ1CM-106Z	E CAPACITOR	10uF 16V M		C411	QEKJ1AM-227Z	E CAPACITOR	220uF 10V M	
C102	QEKJ1CM-226Z	E CAPACITOR	22uF 16V M		C412	NCB31EK-473X	C CAPACITOR	0.047uF 25V K	
C103	QEKJ0JM-476Z	E CAPACITOR	47uF 6.3V M		C413	QCZ0202-155Z	C CAPACITOR	1.5uF 25V Z	
C109	NCB31EK-223X	C CAPACITOR	0.022uF 25V K		C414	QERF0JM-337Z	E CAPACITOR	330uF 6.3V M	
C110	QEKJ1CM-476Z	E CAPACITOR	47uF 16V M		C415	NCS31HJ-101X	C CAPACITOR	100pF 50V J	
C111	QEKJ1CM-106Z	E CAPACITOR	10uF 16V M		C416	NCB31HK-103X	C CAPACITOR	0.01uF 50V K	
C112	QEKJ1CM-226Z	E CAPACITOR	22uF 16V M		C422	NCB31EK-103X	C CAPACITOR	0.01uF 25V K	
C113	QEKJ0JM-476Z	E CAPACITOR	47uF 6.3V M		C423	QEKJ1AM-227Z	E CAPACITOR	220uF 10V M	
C155	NCB31AK-474X	C CAPACITOR	0.47uF 10V K		C424	NCS31HJ-151X	C CAPACITOR	150pF 50V J	
C156	NCB31EK-473X	C CAPACITOR	0.047uF 25V K		C425	NCS31HJ-101X	C CAPACITOR	100pF 50V J	
C161	QTE1A57-107Z	E CAPACITOR	100uF 10V		C426	NCS31HJ-221X	C CAPACITOR	220pF 50V J	
C162	NCB31CK-473X	C CAPACITOR	0.047uF 16V K		C427	QEKJ1EM-475Z	E CAPACITOR	4.7uF 25V M	
C163	NFV81CM-105X	MF CAPACITOR	1uF 16V M		C428	QEKJ1EM-475Z	E CAPACITOR	4.7uF 25V M	
C164	NFV81CM-105X	MF CAPACITOR	1uF 16V M		C432	NCB31EK-103X	C CAPACITOR	0.01uF 25V K	
C165	NFV81CM-105X	MF CAPACITOR	1uF 16V M		C433	QEKJ1AM-227Z	E CAPACITOR	220uF 10V M	
C166	QTE1C57-106Z	E CAPACITOR	10uF 16V		C434	NCS31HJ-151X	C CAPACITOR	150pF 50V J	
C168	QEKJ1HM-225Z	E CAPACITOR	2.2uF 50V M		C435	NCS31HJ-101X	C CAPACITOR	100pF 50V J	
C169	NCB31HK-103X	C CAPACITOR	0.01uF 50V K		C436	NCS31HJ-221X	C CAPACITOR	220pF 50V J	
C170	QEKJ1CM-106Z	E CAPACITOR	10uF 16V M		C437	QEKJ1EM-475Z	E CAPACITOR	4.7uF 25V M	
C171	QTE1H57-225Z	E CAPACITOR	2.2uF 50V		C438	QEKJ1EM-475Z	E CAPACITOR	4.7uF 25V M	
C172	QTE1H55-225Z	E CAPACITOR	2.2uF 50V		C441	QEKJ0JM-476Z	E CAPACITOR	47uF 6.3V M	
C174	QEKJ1HM-225Z	E CAPACITOR	2.2uF 50V M		C451	QEKJ0JM-476Z	E CAPACITOR	47uF 6.3V M	
C175	NCB31HK-471X	C CAPACITOR	470pF 50V K		C461	QEKJ1CM-226Z	E CAPACITOR	22uF 16V M	
C176	QEKJ1HM-225Z	E CAPACITOR	2.2uF 50V M		C462	QEKJ1AM-107Z	E CAPACITOR	100uF 10V M	
C177	QEKJ1HM-225Z	E CAPACITOR	2.2uF 50V M		C463	NCF31CZ-104X	C CAPACITOR	0.1uF 16V Z	
C181	QTE1H57-225Z	E CAPACITOR	2.2uF 50V		C464	QEKJ1AM-107Z	E CAPACITOR	100uF 10V M	
C182	QTE1H55-225Z	E CAPACITOR	2.2uF 50V		C465	NCF31CZ-104X	C CAPACITOR	0.1uF 16V Z	
C184	QEKJ1HM-225Z	E CAPACITOR	2.2uF 50V M		C701	NCB31HK-103X	C CAPACITOR	0.01uF 50V K	
C185	NCB31HK-471X	C CAPACITOR	470pF 50V K		C702	NCB31CK-104X	C CAPACITOR	0.1uF 16V K	
C186	QEKJ1HM-225Z	E CAPACITOR	2.2uF 50V M		C703	NDC31HJ-101X	C CAPACITOR	100pF 50V J	
C187	QEKJ1HM-225Z	E CAPACITOR	2.2uF 50V M		C704	NCB31AK-474X	C CAPACITOR	0.47uF 10V K	
C191	QEKJ0JM-476Z	E CAPACITOR	47uF 6.3V M		C705	NDC31HJ-101X	C CAPACITOR	100pF 50V J	
C267	QEKJ1CM-106Z	E CAPACITOR	10uF 16V M		C721	NCB31EK-473X	C CAPACITOR	0.047uF 25V K	
C301	QEKJ1CM-476Z	E CAPACITOR	47uF 16V M		C722	QEKJ1AM-227Z	E CAPACITOR	220uF 10V M	
C302	NCB31HK-103X	C CAPACITOR	0.01uF 50V K		C723	NCS31HJ-471X	C CAPACITOR	470pF 50V J	
C311	NBE21CM-475X	TA E CAPACITOR	4.7uF 16V M		C724	NCS31HJ-471X	C CAPACITOR	470pF 50V J	
C312	QTE1C57-476Z	E CAPACITOR	47uF 16V		C725	QEKJ1AM-227Z	E CAPACITOR	220uF 10V M	
C313	NCB31HK-103X	C CAPACITOR	0.01uF 50V K		C726	NDC31HJ-8R0X	C CAPACITOR	8pF 50V J	
C314	QEKJ1HM-225Z	E CAPACITOR	2.2uF 50V M		C727	NDC31HJ-270X	C CAPACITOR	27pF 50V J	
C315	QEKJ1CM-226Z	E CAPACITOR	22uF 16V M		C728	NDC31HJ-270X	C CAPACITOR	27pF 50V J	
C316	NCB31HK-103X	C CAPACITOR	0.01uF 50V K		C729	NDC31HJ-220X	C CAPACITOR	22pF 50V J	
C326	QEKJ1EM-475Z	E CAPACITOR	4.7uF 25V M		C730	QEKJ0JM-476Z	E CAPACITOR	47uF 6.3V M	
C328	NFV81CM-105X	MF CAPACITOR	1uF 16V M		C731	NCB31CK-103X	C CAPACITOR	0.01uF 16V K	
C329	NCS31HJ-101X	C CAPACITOR	100pF 50V J		C732	QEKJ1AM-227Z	E CAPACITOR	220uF 10V M	
C331	NCB31HK-223X	C CAPACITOR	0.022uF 50V K		C733	NCS31HJ-471X	C CAPACITOR	470pF 50V J	
C336	QEKJ1EM-475Z	E CAPACITOR	4.7uF 25V M		C781	QEKJ0JM-476Z	E CAPACITOR	47uF 6.3V M	
C338	NFV81CM-105X	MF CAPACITOR	1uF 16V M		C782	QEKJ0JM-476Z	E CAPACITOR	47uF 6.3V M	
C339	NCS31HJ-101X	C CAPACITOR	100pF 50V J		C783	QEKJ1AM-227Z	E CAPACITOR	220uF 10V M	
C346	QEKJ1EM-475Z	E CAPACITOR	4.7uF 25V M		C802	NCS31HJ-220X	C CAPACITOR	22pF 50V J	
C348	NFV81CM-105X	MF CAPACITOR	1uF 16V M		C803	NCB31CK-473X	C CAPACITOR	0.047uF 16V K	
C349	NCS31HJ-101X	C CAPACITOR	100pF 50V J		C804	NCS31HJ-220X	C CAPACITOR	22pF 50V J	
C356	QEKJ1EM-475Z	E CAPACITOR	4.7uF 25V M		C821	QEKJ1CM-106Z	E CAPACITOR	10uF 16V M	
C358	NFV81CM-105X	MF CAPACITOR	1uF 16V M		C822	QEKJ1CM-106Z	E CAPACITOR	10uF 16V M	
C359	NCS31HJ-101X	C CAPACITOR	100pF 50V J		C823	NCB31HK-103X	C CAPACITOR	0.01uF 50V K	
C373	QEKJ1EM-475Z	E CAPACITOR	4.7uF 25V M		C831	NCS31HJ-101X	C CAPACITOR	100pF 50V J	
C374	QEKJ1EM-475Z	E CAPACITOR	4.7uF 25V M		C881	QEKJ1CM-226Z	E CAPACITOR	22uF 16V M	

△ Symbol No.	Part No.	Part Name	Description	Local	△ Symbol No.	Part No.	Part Name	Description	Local
C885	QEKJ1CM-106Z	E CAPACITOR	10uF 16V M		R93	NRSA63J-472X	MG RESISTOR	4.7kΩ 1/16W J	
C892	NCB31CK-104X	C CAPACITOR	0.1uF 16V K		R101	NRSA63J-473X	MG RESISTOR	47kΩ 1/16W J	
C901	QEZ0722-338	E CAPACITOR	3300uF		R102	NRSA63J-103X	MG RESISTOR	10kΩ 1/16W J	
C902	QEKJ1HM-225Z	E CAPACITOR	2.2uF 50V M		R103	NRSA63J-103X	MG RESISTOR	10kΩ 1/16W J	
C903	QEKJ1CM-106Z	E CAPACITOR	10uF 16V M		R104	NRSA63J-103X	MG RESISTOR	10kΩ 1/16W J	
C905	QEKJ1AM-107Z	E CAPACITOR	100uF 10V M		R105	NRSA63J-103X	MG RESISTOR	10kΩ 1/16W J	
C906	NCF31CZ-104X	C CAPACITOR	0.1uF 16V Z		R106	NRSA63J-103X	MG RESISTOR	10kΩ 1/16W J	
C907	NCB31HK-103X	C CAPACITOR	0.01uF 50V K		R107	NRSA63J-103X	MG RESISTOR	10kΩ 1/16W J	
C908	QEKJ1AM-227Z	E CAPACITOR	220uF 10V M		R110	NRSA63J-0R0X	MG RESISTOR	0Ω 1/16W J	
C909	QEKJ1CM-107Z	E CAPACITOR	100uF 16V M		R111	NRSA63J-473X	MG RESISTOR	47kΩ 1/16W J	
C910	NCB31HK-102X	C CAPACITOR	1000pF 50V K		R112	NRSA63J-103X	MG RESISTOR	10kΩ 1/16W J	
C911	NCB31HK-102X	C CAPACITOR	1000pF 50V K		R113	NRSA63J-103X	MG RESISTOR	10kΩ 1/16W J	
C912	QEKJ1CM-226Z	E CAPACITOR	22uF 16V M		R114	NRSA63J-103X	MG RESISTOR	10kΩ 1/16W J	
C913	NCB31EK-473X	C CAPACITOR	0.047uF 25V K		R115	NRSA63J-103X	MG RESISTOR	10kΩ 1/16W J	
C921	QEKJ1AM-227Z	E CAPACITOR	220uF 10V M		R116	NRSA63J-103X	MG RESISTOR	10kΩ 1/16W J	
C922	QEKJ1AM-107Z	E CAPACITOR	100uF 10V M		R117	NRSA63J-103X	MG RESISTOR	10kΩ 1/16W J	
C925	QEKJ1AM-227Z	E CAPACITOR	220uF 10V M		R141	NRSA63J-473X	MG RESISTOR	47kΩ 1/16W J	
C926	QEXF1AM-476Z	E CAPACITOR	47uF 10V M		R151	NRSA63J-473X	MG RESISTOR	47kΩ 1/16W J	
C927	QEZ0595-477Z	E CAPACITOR	470uF		R155	NRSA63J-471X	MG RESISTOR	470Ω 1/16W J	
C928	NCF31CZ-104X	C CAPACITOR	0.1uF 16V Z		R161	NRSA63J-0R0X	MG RESISTOR	0Ω 1/16W J	
C929	NCB31HK-472X	C CAPACITOR	4700pF 50V K		R162	NRSA63J-473X	MG RESISTOR	47kΩ 1/16W J	
C930	NCF31CZ-104X	C CAPACITOR	0.1uF 16V Z		R163	NRSA63J-473X	MG RESISTOR	47kΩ 1/16W J	
C961	QEKJ1AM-227Z	E CAPACITOR	220uF 10V M		R164	NRSA63J-473X	MG RESISTOR	47kΩ 1/16W J	
C962	QEKJ1AM-227Z	E CAPACITOR	220uF 10V M		R165	NRSA63J-473X	MG RESISTOR	47kΩ 1/16W J	
C963	QEKJ1AM-227Z	E CAPACITOR	220uF 10V M		R166	NRSA63J-221X	MG RESISTOR	220Ω 1/16W J	
C964	QEKJ1AM-227Z	E CAPACITOR	220uF 10V M		R167	NRSA63J-222X	MG RESISTOR	2.2kΩ 1/16W J	
C965	QEKJ1AM-227Z	E CAPACITOR	220uF 10V M		R168	NRSA63J-222X	MG RESISTOR	2.2kΩ 1/16W J	
C966	NCB31CK-104X	C CAPACITOR	0.1uF 16V K		R169	NRSA63J-222X	MG RESISTOR	2.2kΩ 1/16W J	
C967	NCB31CK-104X	C CAPACITOR	0.1uF 16V K		R170	NRSA63J-222X	MG RESISTOR	2.2kΩ 1/16W J	
C968	NCB31EK-473X	C CAPACITOR	0.047uF 25V K		R171	NRSA63J-222X	MG RESISTOR	2.2kΩ 1/16W J	
C969	NCB31EK-473X	C CAPACITOR	0.047uF 25V K		R172	NRSA63J-222X	MG RESISTOR	2.2kΩ 1/16W J	
C981	NCB31CK-104X	C CAPACITOR	0.1uF 16V K		R173	NRSA63J-0R0X	MG RESISTOR	0Ω 1/16W J	
C997	NCB31HK-103X	C CAPACITOR	0.01uF 50V K		R191	NRSA63J-472X	MG RESISTOR	4.7kΩ 1/16W J	
C999	NCS31HJ-101X	C CAPACITOR	100pF 50V J		R192	NRSA63J-821X	MG RESISTOR	820Ω 1/16W J	
R1	NRSA63J-473X	MG RESISTOR	47kΩ 1/16W J		R193	NRSA63J-101X	MG RESISTOR	100Ω 1/16W J	
R2	NRS181J-220X	MG RESISTOR	22Ω 1/8W J		R302	NRSA63J-0R0X	MG RESISTOR	0Ω 1/16W J	
R3	NRS181J-220X	MG RESISTOR	22Ω 1/8W J		R303	NRSA63J-0R0X	MG RESISTOR	0Ω 1/16W J	
R4	NRSA63J-473X	MG RESISTOR	47kΩ 1/16W J		R304	NRSA63J-473X	MG RESISTOR	47kΩ 1/16W J	
R5	NRSA63J-472X	MG RESISTOR	4.7kΩ 1/16W J		R305	NRSA63J-103X	MG RESISTOR	10kΩ 1/16W J	
R6	NRSA63J-332X	MG RESISTOR	3.3kΩ 1/16W J		R306	NRSA63J-273X	MG RESISTOR	27kΩ 1/16W J	
R7	NRSA63J-473X	MG RESISTOR	47kΩ 1/16W J		R307	NRSA63J-100X	MG RESISTOR	10Ω 1/16W J	
R8	NRS181J-0R0X	MG RESISTOR	0Ω 1/8W J		R308	NRSA63J-222X	MG RESISTOR	2.2kΩ 1/16W J	
R9	NRSA63J-100X	MG RESISTOR	10Ω 1/16W J		R323	NRSA63J-473X	MG RESISTOR	47kΩ 1/16W J	
R11	NRSA63J-472X	MG RESISTOR	4.7kΩ 1/16W J		R324	NRSA63J-222X	MG RESISTOR	2.2kΩ 1/16W J	
R13	NRSA63J-0R0X	MG RESISTOR	0Ω 1/16W J		R325	NRSA63J-102X	MG RESISTOR	1kΩ 1/16W J	
R14	NRSA63J-103X	MG RESISTOR	10kΩ 1/16W J		R326	NRSA63J-101X	MG RESISTOR	100Ω 1/16W J	
R31	NRSA63J-470X	MG RESISTOR	47Ω 1/16W J		R327	NRSA63J-0R0X	MG RESISTOR	0Ω 1/16W J	
R32	NRSA63J-0R0X	MG RESISTOR	0Ω 1/16W J		R328	NRSA63J-473X	MG RESISTOR	47kΩ 1/16W J	
R33	NRSA63J-101X	MG RESISTOR	100Ω 1/16W J		R329	NRSA63J-513X	MG RESISTOR	51kΩ 1/16W J	
R34	NRSA63J-103X	MG RESISTOR	10kΩ 1/16W J		R330	NRSA63J-102X	MG RESISTOR	1kΩ 1/16W J	
R35	NRSA63J-393X	MG RESISTOR	39kΩ 1/16W J		R333	NRSA63J-473X	MG RESISTOR	47kΩ 1/16W J	
R36	NRSA63J-221X	MG RESISTOR	220Ω 1/16W J		R334	NRSA63J-222X	MG RESISTOR	2.2kΩ 1/16W J	
R37	NRSA63J-471X	MG RESISTOR	470Ω 1/16W J		R335	NRSA63J-102X	MG RESISTOR	1kΩ 1/16W J	
R38	NRSA63J-100X	MG RESISTOR	10Ω 1/16W J		R336	NRSA63J-101X	MG RESISTOR	100Ω 1/16W J	
R39	NRSA63J-622X	MG RESISTOR	6.2kΩ 1/16W J		R337	NRSA63J-0R0X	MG RESISTOR	0Ω 1/16W J	
R40	NRSA63J-472X	MG RESISTOR	4.7kΩ 1/16W J		R338	NRSA63J-473X	MG RESISTOR	47kΩ 1/16W J	
R42	NRSA63J-103X	MG RESISTOR	10kΩ 1/16W J		R339	NRSA63J-513X	MG RESISTOR	51kΩ 1/16W J	
R43	NRSA63J-103X	MG RESISTOR	10kΩ 1/16W J		R340	NRSA63J-102X	MG RESISTOR	1kΩ 1/16W J	
R44	NRSA63J-103X	MG RESISTOR	10kΩ 1/16W J		R343	NRSA63J-473X	MG RESISTOR	47kΩ 1/16W J	
R51	NRSA63J-473X	MG RESISTOR	47kΩ 1/16W J		R344	NRSA63J-222X	MG RESISTOR	2.2kΩ 1/16W J	
R52	NRSA63J-273X	MG RESISTOR	27kΩ 1/16W J		R345	NRSA63J-102X	MG RESISTOR	1kΩ 1/16W J	
R53	NRSA63J-473X	MG RESISTOR	47kΩ 1/16W J		R346	NRSA63J-101X	MG RESISTOR	100Ω 1/16W J	
R54	NRSA63J-222X	MG RESISTOR	2.2kΩ 1/16W J		R347	NRSA63J-0R0X	MG RESISTOR	0Ω 1/16W J	
R55	NRSA63J-473X	MG RESISTOR	47kΩ 1/16W J		R348	NRSA63J-473X	MG RESISTOR	47kΩ 1/16W J	
R56	NRSA63J-103X	MG RESISTOR	10kΩ 1/16W J		R349	NRSA63J-513X	MG RESISTOR	51kΩ 1/16W J	
R57	NRSA63J-103X	MG RESISTOR	10kΩ 1/16W J		R350	NRSA63J-102X	MG RESISTOR	1kΩ 1/16W J	
R58	NRSA63J-153X	MG RESISTOR	15kΩ 1/16W J		R353	NRSA63J-473X	MG RESISTOR	47kΩ 1/16W J	
R59	NRSA63J-471X	MG RESISTOR	470Ω 1/16W J		R354	NRSA63J-222X	MG RESISTOR	2.2kΩ 1/16W J	
R72	NRSA63J-0R0X	MG RESISTOR	0Ω 1/16W J		R355	NRSA63J-102X	MG RESISTOR	1kΩ 1/16W J	
R73	NRSA63J-222X	MG RESISTOR	2.2kΩ 1/16W J		R356	NRSA63J-101X	MG RESISTOR	100Ω 1/16W J	
R74	NRSA63J-222X	MG RESISTOR	2.2kΩ 1/16W J		R357	NRSA63J-0R0X	MG RESISTOR	0Ω 1/16W J	
R75	NRSA63J-222X	MG RESISTOR	2.2kΩ 1/16W J		R358	NRSA63J-473X	MG RESISTOR	47kΩ 1/16W J	
R81	NRSA63J-113X	MG RESISTOR	11kΩ 1/16W J		R359	NRSA63J-513X	MG RESISTOR	51kΩ 1/16W J	
R82	NRSA63J-183X	MG RESISTOR	18kΩ 1/16W J		R360	NRSA63J-102X	MG RESISTOR	1kΩ 1/16W J	
R83	NRSA63J-472X	MG RESISTOR	4.7kΩ 1/16W J		R371	NRSA63J-102X	MG RESISTOR	1kΩ 1/16W J	
R91	NRSA63J-113X	MG RESISTOR	11kΩ 1/16W J		R372	NRSA63J-102X	MG RESISTOR	1kΩ 1/16W J	
R92	NRSA63J-183X	MG RESISTOR	18kΩ 1/16W J		R373	NRSA63J-104X	MG RESISTOR	100kΩ 1/16W J	
					R374	NRSA63J-104X	MG RESISTOR	100kΩ 1/16W J	

△ Symbol No.	Part No.	Part Name	Description	Local	△ Symbol No.	Part No.	Part Name	Description	Local
R375	NRSA63J-223X	MG RESISTOR	22kΩ 1/16W J		R735	NRSA63J-0R0X	MG RESISTOR	0Ω 1/16W J	
R376	NRSA63J-223X	MG RESISTOR	22kΩ 1/16W J		R736	NRSA63J-222X	MG RESISTOR	2.2kΩ 1/16W J	
R377	NRSA63J-333X	MG RESISTOR	33kΩ 1/16W J		R737	NRSA63J-222X	MG RESISTOR	2.2kΩ 1/16W J	
R378	NRSA63J-333X	MG RESISTOR	33kΩ 1/16W J		R738	NRSA63J-472X	MG RESISTOR	4.7kΩ 1/16W J	
R381	NRSA63J-102X	MG RESISTOR	1kΩ 1/16W J		R739	NRSA63J-472X	MG RESISTOR	4.7kΩ 1/16W J	
R382	NRSA63J-102X	MG RESISTOR	1kΩ 1/16W J		R740	NRSA63J-222X	MG RESISTOR	2.2kΩ 1/16W J	
R383	NRSA63J-104X	MG RESISTOR	100kΩ 1/16W J		R743	NRSA63J-473X	MG RESISTOR	47kΩ 1/16W J	
R384	NRSA63J-104X	MG RESISTOR	100kΩ 1/16W J		R744	NRSA63J-821X	MG RESISTOR	820Ω 1/16W J	
R385	NRSA63J-223X	MG RESISTOR	22kΩ 1/16W J		R745	NRSA63J-106X	MG RESISTOR	10MΩ 1/16W J	
R386	NRSA63J-223X	MG RESISTOR	22kΩ 1/16W J		R746	NRSA63J-473X	MG RESISTOR	47kΩ 1/16W J	
R387	NRSA63J-333X	MG RESISTOR	33kΩ 1/16W J		R747	NRSA63J-473X	MG RESISTOR	47kΩ 1/16W J	
R388	NRSA63J-333X	MG RESISTOR	33kΩ 1/16W J		R750	NRSA63J-473X	MG RESISTOR	47kΩ 1/16W J	
R401	NRSA63J-471X	MG RESISTOR	470Ω 1/16W J		R751	NRSA63J-333X	MG RESISTOR	33kΩ 1/16W J	
R402	NRSA63J-100X	MG RESISTOR	10Ω 1/16W J		R752	NRSA63J-223X	MG RESISTOR	22kΩ 1/16W J	
R403	NRSA63J-471X	MG RESISTOR	470Ω 1/16W J		R753	NRSA63J-222X	MG RESISTOR	2.2kΩ 1/16W J	
R404	NRSA63J-1R0X	MG RESISTOR	1Ω 1/16W J		R754	NRSA63J-222X	MG RESISTOR	2.2kΩ 1/16W J	
R411	NRSA63J-0R0X	MG RESISTOR	0Ω 1/16W J		R755	NRSA63J-103X	MG RESISTOR	10kΩ 1/16W J	
R412	NRSA63D-682X	MG RESISTOR	6.8kΩ 1/16W D		R756	NRSA63J-222X	MG RESISTOR	2.2kΩ 1/16W J	
R413	NRSA63J-100X	MG RESISTOR	10Ω 1/16W J		R757	NRSA63J-473X	MG RESISTOR	47kΩ 1/16W J	
R414	NRSA63J-102X	MG RESISTOR	1kΩ 1/16W J		R758	NRSA63J-224X	MG RESISTOR	220kΩ 1/16W J	
R415	NRSA63J-750X	MG RESISTOR	75Ω 1/16W J		R759	NRSA63J-224X	MG RESISTOR	220kΩ 1/16W J	
R416	NRSA63J-0R0X	MG RESISTOR	0Ω 1/16W J		R760	NRSA63J-472X	MG RESISTOR	4.7kΩ 1/16W J	
R417	NRSA63D-181X	MG RESISTOR	180Ω 1/16W D		R761	NRSA63J-472X	MG RESISTOR	4.7kΩ 1/16W J	
R421	NRSA63J-220X	MG RESISTOR	22Ω 1/16W J		R762	NRSA63J-472X	MG RESISTOR	4.7kΩ 1/16W J	
R422	NRSA63J-102X	MG RESISTOR	1kΩ 1/16W J		R763	NRSA63J-103X	MG RESISTOR	10kΩ 1/16W J	
R423	NRSA63J-102X	MG RESISTOR	1kΩ 1/16W J		R765	NRSA63J-103X	MG RESISTOR	10kΩ 1/16W J	
R424	NRSA63J-390X	MG RESISTOR	39Ω 1/16W J		R767	NRSA63J-103X	MG RESISTOR	10kΩ 1/16W J	
R425	NRSA63J-102X	MG RESISTOR	1kΩ 1/16W J		R768	NRSA63J-103X	MG RESISTOR	10kΩ 1/16W J	
R426	NRSA63J-183X	MG RESISTOR	18kΩ 1/16W J		R769	NRSA63J-473X	MG RESISTOR	47kΩ 1/16W J	
R427	NRSA63J-682X	MG RESISTOR	6.8kΩ 1/16W J		R770	NRSA63J-102X	MG RESISTOR	1kΩ 1/16W J	
R428	NRSA63J-472X	MG RESISTOR	4.7kΩ 1/16W J		R771	NRSA63J-392X	MG RESISTOR	3.9kΩ 1/16W J	
R429	NRSA63J-104X	MG RESISTOR	100kΩ 1/16W J		R772	NRSA63J-392X	MG RESISTOR	3.9kΩ 1/16W J	
R431	NRSA63J-220X	MG RESISTOR	22Ω 1/16W J		R773	NRSA63J-392X	MG RESISTOR	3.9kΩ 1/16W J	
R432	NRSA63J-102X	MG RESISTOR	1kΩ 1/16W J		R774	NRSA63J-472X	MG RESISTOR	4.7kΩ 1/16W J	
R433	NRSA63J-102X	MG RESISTOR	1kΩ 1/16W J		R775	NRSA63J-472X	MG RESISTOR	4.7kΩ 1/16W J	
R434	NRSA63J-390X	MG RESISTOR	39Ω 1/16W J		R776	NRSA63J-472X	MG RESISTOR	4.7kΩ 1/16W J	
R435	NRSA63J-102X	MG RESISTOR	1kΩ 1/16W J		R777	NRSA63J-102X	MG RESISTOR	1kΩ 1/16W J	
R436	NRSA63J-183X	MG RESISTOR	18kΩ 1/16W J		R779	NRSA63J-222X	MG RESISTOR	2.2kΩ 1/16W J	
R437	NRSA63J-682X	MG RESISTOR	6.8kΩ 1/16W J		R780	NRSA63J-222X	MG RESISTOR	2.2kΩ 1/16W J	
R438	NRSA63J-472X	MG RESISTOR	4.7kΩ 1/16W J		R781	NRSA63J-471X	MG RESISTOR	470Ω 1/16W J	
R439	NRSA63J-104X	MG RESISTOR	100kΩ 1/16W J		R782	NRSA63J-471X	MG RESISTOR	470Ω 1/16W J	
R441	NRSA63J-223X	MG RESISTOR	22kΩ 1/16W J		R799	NRSA63J-222X	MG RESISTOR	2.2kΩ 1/16W J	
R442	NRSA63J-223X	MG RESISTOR	22kΩ 1/16W J		R801	NRSA63J-101X	MG RESISTOR	100Ω 1/16W J	
R451	NRSA63J-223X	MG RESISTOR	22kΩ 1/16W J		R802	NRSA63J-473X	MG RESISTOR	47kΩ 1/16W J	
R452	NRSA63J-223X	MG RESISTOR	22kΩ 1/16W J		R803	NRSA63J-223X	MG RESISTOR	22kΩ 1/16W J	
R461	NRSA63J-100X	MG RESISTOR	10Ω 1/16W J		R804	NRSA63J-104X	MG RESISTOR	100kΩ 1/16W J	
R462	NRSA63J-100X	MG RESISTOR	10Ω 1/16W J		R805	NRSA63J-103X	MG RESISTOR	10kΩ 1/16W J	
R463	NRSA63J-100X	MG RESISTOR	10Ω 1/16W J		R806	NRSA63J-104X	MG RESISTOR	100kΩ 1/16W J	
R701	NRSA63J-0R0X	MG RESISTOR	0Ω 1/16W J		R807	NRSA63J-331X	MG RESISTOR	330Ω 1/16W J	
R702	NRSA63J-0R0X	MG RESISTOR	0Ω 1/16W J		R808	NRSA63J-223X	MG RESISTOR	22kΩ 1/16W J	
R703	NRSA63J-0R0X	MG RESISTOR	0Ω 1/16W J		R809	NRSA63J-101X	MG RESISTOR	100Ω 1/16W J	
R704	NRSA63J-271X	MG RESISTOR	270Ω 1/16W J		R810	NRSA63J-473X	MG RESISTOR	47kΩ 1/16W J	
R705	NRSA63J-271X	MG RESISTOR	270Ω 1/16W J		R821	NRSA63J-100X	MG RESISTOR	10Ω 1/16W J	
R706	NRSA63J-103X	MG RESISTOR	10kΩ 1/16W J		R822	NRSA63J-471X	MG RESISTOR	470Ω 1/16W J	
R707	NRSA63J-103X	MG RESISTOR	10kΩ 1/16W J		R831	NRSA63J-0R0X	MG RESISTOR	0Ω 1/16W J	
R708	NRS181J-331X	MG RESISTOR	330Ω 1/8W J		R832	NRSA63J-271X	MG RESISTOR	270Ω 1/16W J	
R709	NRSA63J-562X	MG RESISTOR	5.6kΩ 1/16W J		R841	NRSA63J-473X	MG RESISTOR	47kΩ 1/16W J	
R710	NRSA63J-102X	MG RESISTOR	1kΩ 1/16W J		R842	NRSA63J-473X	MG RESISTOR	47kΩ 1/16W J	
R711	NRSA63J-103X	MG RESISTOR	10kΩ 1/16W J		R845	NRSA63J-222X	MG RESISTOR	2.2kΩ 1/16W J	
R712	NRSA63J-104X	MG RESISTOR	100kΩ 1/16W J		R881	NRSA63J-473X	MG RESISTOR	47kΩ 1/16W J	
R713	NRSA63J-103X	MG RESISTOR	10kΩ 1/16W J		R882	NRSA63J-103X	MG RESISTOR	10kΩ 1/16W J	
R714	NRSA63J-104X	MG RESISTOR	100kΩ 1/16W J		R883	NRSA63J-104X	MG RESISTOR	100kΩ 1/16W J	
R715	NRSA63J-271X	MG RESISTOR	270Ω 1/16W J		R885	NRSA63J-473X	MG RESISTOR	47kΩ 1/16W J	
R716	NRSA63J-271X	MG RESISTOR	270Ω 1/16W J		R886	NRSA63J-472X	MG RESISTOR	4.7kΩ 1/16W J	
R717	NRSA63J-103X	MG RESISTOR	10kΩ 1/16W J		R887	NRSA63J-103X	MG RESISTOR	10kΩ 1/16W J	
R718	NRSA63J-103X	MG RESISTOR	10kΩ 1/16W J		R888	NRSA63J-0R0X	MG RESISTOR	0Ω 1/16W J	
R719	NRSA63J-102X	MG RESISTOR	1kΩ 1/16W J		R889	NRSA63J-0R0X	MG RESISTOR	0Ω 1/16W J	
R720	NRSA63J-102X	MG RESISTOR	1kΩ 1/16W J		R891	NRSA63J-473X	MG RESISTOR	47kΩ 1/16W J	
R721	NRSA63J-222X	MG RESISTOR	2.2kΩ 1/16W J		R892	NRSA63J-102X	MG RESISTOR	1kΩ 1/16W J	
R722	NRSA63J-222X	MG RESISTOR	2.2kΩ 1/16W J		R894	NRSA63J-0R0X	MG RESISTOR	0Ω 1/16W J	
R725	NRSA63J-473X	MG RESISTOR	47kΩ 1/16W J		R901	QRE142J-102X	C RESISTOR	1kΩ 1/4W J	
R726	NRSA63J-103X	MG RESISTOR	10kΩ 1/16W J		R902	NRSA63J-912X	MG RESISTOR	9.1kΩ 1/16W J	
R727	NRSA63J-562X	MG RESISTOR	5.6kΩ 1/16W J		R903	NRSA63J-472X	MG RESISTOR	4.7kΩ 1/16W J	
R728	NRSA63J-472X	MG RESISTOR	4.7kΩ 1/16W J		R909	NRSA63J-473X	MG RESISTOR	47kΩ 1/16W J	
R729	NRSA63J-0R0X	MG RESISTOR	0Ω 1/16W J		R910	NRSA63J-222X	MG RESISTOR	2.2kΩ 1/16W J	
R730	NRSA63J-222X	MG RESISTOR	2.2kΩ 1/16W J		R914	NRS181J-221X	MG RESISTOR	220Ω 1/8W J	
R732	NRSA63J-222X	MG RESISTOR	2.2kΩ 1/16W J		R921	NRS181J-0R0X	MG RESISTOR	0Ω 1/8W J	
R733	NRSA63J-103X	MG RESISTOR	10kΩ 1/16W J		R923	NRSA63J-393X	MG RESISTOR	39kΩ 1/16W J	

△ Symbol No.	Part No.	Part Name	Description	Local
R924	NRSA63J-103X	MG RESISTOR	10kΩ 1/16W J	
R925	NRSA63J-154X	MG RESISTOR	150kΩ 1/16W J	
R926	NRSA63J-394X	MG RESISTOR	390kΩ 1/16W J	
R927	NRSA63J-0R0X	MG RESISTOR	0Ω 1/16W J	
R928	NRSA63J-473X	MG RESISTOR	47kΩ 1/16W J	
R961	NRS181J-0R0X	MG RESISTOR	0Ω 1/8W J	
R962	NRSA63J-101X	MG RESISTOR	100Ω 1/16W J	
R967	NRS181J-0R0X	MG RESISTOR	0Ω 1/8W J	
R968	NRS181J-0R0X	MG RESISTOR	0Ω 1/8W J	
R969	NRS181J-0R0X	MG RESISTOR	0Ω 1/8W J	
R973	NRSA63J-103X	MG RESISTOR	10kΩ 1/16W J	
R974	NRSA63J-103X	MG RESISTOR	10kΩ 1/16W J	
R975	NRSA63J-103X	MG RESISTOR	10kΩ 1/16W J	
R976	NRSA63J-563X	MG RESISTOR	56kΩ 1/16W J	
R977	NRSA63J-183X	MG RESISTOR	18kΩ 1/16W J	
R981	NRS181J-222X	MG RESISTOR	2.2kΩ 1/8W J	
R982	NRS181J-222X	MG RESISTOR	2.2kΩ 1/8W J	
RA31	NRZ0065-222X	NET RESISTOR	2.2kΩ	
RA721	NRZ0065-222X	NET RESISTOR	2.2kΩ	
RA723	NRZ0065-103X	NET RESISTOR	10kΩ 1/16W J	
L1	NQL334J-4R7X	COIL	4.7uH J	
L31	NQL114K-470X	INDUCTOR	47uH K	
L401	NQR0007-002X	FERRITE BEADS		
L411	NQL114K-470X	INDUCTOR	47uH K	
L421	NQR0007-002X	FERRITE BEADS		
L430	NQR0007-002X	FERRITE BEADS		
L431	NQR0007-002X	FERRITE BEADS		
L721	NQL38DK-330X	COIL	33uH K	
L722	NQL114K-470X	INDUCTOR	47uH K	
L901	QQR1378-002	COIL		
L902	NQL56CK-220X	COIL	22uH K	
L924	NQL56CK-220X	COIL	22uH K	
L925	NQL71EM-330X	COIL	33uH M	
L927	NQLB7GM-100X	COIL	10uH M	
CN141	QGA2006C1-04	CONNECTOR	W-B (1-4)	
CN191	QGA2501C3-03Z	CONNECTOR	W-B (1-3)	
CN411	QGA2501F1-02	CONNECTOR	W-B (1-2)	
CN421	QGA2501C3-03Z	CONNECTOR	W-B (1-3)	
CN701	QNZ0605-001	CAR CONNECTOR		
CN821	QGA2001C1-02	CONNECTOR	W-B (1-2)	
CN831	QGA2006F1-02	CONNECTOR	W-B (1-2)	
CN901	QNZ0607-001	CAR CONNECTOR		
CN961	QGB2027M3-30S	CONNECTOR	B-B (1-30)	
CN962	QGF0534F3-45X	CONNECTOR	FFC/FPC (1-45)	
CN963	QGB2027L9-30X	CONNECTOR	B-B (1-30)	
J331	QNN0489-001	PIN JACK		
J801	QNZ0095-001	CONNECTOR		
K401	NQR0007-002X	FERRITE BEADS		
K402	NQR0007-002X	FERRITE BEADS		
K411	NQR0201-004X	FERRITE BEADS		
K831	NQR0007-002X	FERRITE BEADS		
K922	NQR0201-004X	FERRITE BEADS		
PP1	QZW0010-001	STYLE PIN		
PP2	QZW0010-001	STYLE PIN		
PP3	QZW0010-001	STYLE PIN		
S701	QSW0451-001	DETECT SW		
S702	QSW0451-001	DETECT SW		
S723	QSW1049-001Z	TACT SW		
TH721	NAD0028-103X	N THERMISTOR	10kΩ	
△ TU21	QAU0313-001	TUNER		
W21	QAM0105-003	CAR CABLE		
X31	QAX0616-001Z	CRYSTAL	10.250MHz	
X71	QAX0263-001Z	CRYSTAL	4.332MHz	
X721	QAX0617-001Z	CRYSTAL	12.500MHz	
X722	QAX0401-001	CRYSTAL	32.768KHz	

Switch board

(KD-DV5201EU,KD-DV5202EU)

Block No. [0][2]

△ Symbol No.	Part No.	Part Name	Description	Local
IC601	PT6523LQ-L	LCD DRIVER		
IC602	RPM7338-V4	RM.RECEIVER		
Q640	2SA1365/F-X	TRANSISTOR		
Q641	RT1N141C-X	DIGI TRANSISTOR		
D601	SML-310VT/JK/-X	LED		
D602	SML-310VT/JK/-X	LED		
D603	SML-310VT/JK/-X	LED		
D604	SML-310VT/JK/-X	LED		
D605	SML-310VT/JK/-X	LED		
D606	SML-310VT/JK/-X	LED		
D607	SML-310VT/JK/-X	LED		
D608	SML310BA1T/HJ-X	LED		
D609	SML310BA1T/HJ-X	LED		
D610	SML-310VT/JK/-X	LED		
D611	SML-310VT/JK/-X	LED		
D612	SML-310VT/JK/-X	LED		
D613	SML-310VT/JK/-X	LED		
D614	SML-310VT/JK/-X	LED		
D615	SML-310VT/JK/-X	LED		
D616	SML-310VT/JK/-X	LED		
D617	SML-310VT/JK/-X	LED		
D618	SML-310VT/JK/-X	LED		
D619	SML-310VT/JK/-X	LED		
D640	MC2838-X	DIODE		
D641	UDZW5.1B-X	SB DIODE		
D642	1SS355W-X	DIODE		
D643	UDZW6.2B-X	Z DIODE		
D645	NSPW310BS/B2RST	LED		
D646	NSPW310BS/B2RST	LED		
C601	NCB31HK-223X	C CAPACITOR	0.022uF 50V K	
C602	NCS31HJ-681X	C CAPACITOR	680pF 50V J	
C603	NBE20JM-106X	TA E CAPACITOR	10uF 6.3V M	
C611	NCB31HK-123X	C CAPACITOR	0.012uF 50V K	
C612	NBE20JM-475X	TA E CAPACITOR	4.7uF 6.3V M	
C620	NCB31HK-473X	C CAPACITOR	0.047uF 50V K	
R601	NRSA63J-821X	MG RESISTOR	820Ω 1/16W J	
R602	NRSA63J-821X	MG RESISTOR	820Ω 1/16W J	
R603	NRSA63J-122X	MG RESISTOR	1.2kΩ 1/16W J	
R604	NRSA63J-182X	MG RESISTOR	1.8kΩ 1/16W J	
R605	NRSA63J-272X	MG RESISTOR	2.7kΩ 1/16W J	
R606	NRSA63J-392X	MG RESISTOR	3.9kΩ 1/16W J	
R607	NRSA63J-821X	MG RESISTOR	820Ω 1/16W J	
R608	NRSA63J-821X	MG RESISTOR	820Ω 1/16W J	
R609	NRSA63J-122X	MG RESISTOR	1.2kΩ 1/16W J	
R610	NRSA63J-182X	MG RESISTOR	1.8kΩ 1/16W J	
R611	NRSA63J-272X	MG RESISTOR	2.7kΩ 1/16W J	
R612	NRSA63J-392X	MG RESISTOR	3.9kΩ 1/16W J	
R613	NRSA63J-821X	MG RESISTOR	820Ω 1/16W J	
R614	NRSA63J-821X	MG RESISTOR	820Ω 1/16W J	
R620	NRSA63J-0R0X	MG RESISTOR	0Ω 1/16W J	
R621	NRSA63J-0R0X	MG RESISTOR	0Ω 1/16W J	
R622	NRSA63J-473X	MG RESISTOR	47kΩ 1/16W J	
R623	NRSA63J-473X	MG RESISTOR	47kΩ 1/16W J	
R624	NRSA63J-471X	MG RESISTOR	470Ω 1/16W J	
R630	NRSA63J-102X	MG RESISTOR	1kΩ 1/16W J	DV5201EU
R630	NRSA63J-122X	MG RESISTOR	1.2kΩ 1/16W J	DV5202EU
R631	NRSA63J-122X	MG RESISTOR	1.2kΩ 1/16W J	DV5202EU
R632	NRSA63J-821X	MG RESISTOR	820Ω 1/16W J	DV5201EU
R632	NRSA63J-122X	MG RESISTOR	1.2kΩ 1/16W J	DV5202EU
R633	NRSA63J-122X	MG RESISTOR	1.2kΩ 1/16W J	DV5202EU
R634	NRSA63J-331X	MG RESISTOR	330Ω 1/16W J	DV5201EU
R634	NRSA63J-271X	MG RESISTOR	270Ω 1/16W J	DV5202EU
R636	NRSA63J-331X	MG RESISTOR	330Ω 1/16W J	DV5201EU
R636	NRSA63J-271X	MG RESISTOR	270Ω 1/16W J	DV5202EU
R638	NRSA63J-471X	MG RESISTOR	470Ω 1/16W J	
R640	NRSA02J-331X	MG RESISTOR	330Ω 1/10W J	
R641	NRSA02J-121X	MG RESISTOR	120Ω 1/10W J	
R642	NRSA02J-331X	MG RESISTOR	330Ω 1/10W J	

△ Symbol No.	Part No.	Part Name	Description	Local	△ Symbol No.	Part No.	Part Name	Description	Local
R643	NRSA02J-201X	MG RESISTOR	200Ω 1/10W J		IC721	UPD784217AGC334	IC		
R644	NRSA63J-471X	MG RESISTOR	470Ω 1/16W J		IC722	BR24L16F-W-X	IC(DIGITAL)		
R646	NRSA63J-471X	MG RESISTOR	470Ω 1/16W J		IC723	S-80833CNNB-G-W	IC		
R648	NRSA63J-331X	MG RESISTOR	330Ω 1/16W J	DV5201EU	IC801	HD74HC126FP-X	IC		
R648	NRSA63J-271X	MG RESISTOR	270Ω 1/16W J	DV5202EU	△ IC901	R2S25400DS-E	IC		
R651	NRSA63J-222X	MG RESISTOR	2.2kΩ 1/16W J		IC921	BA33BC0FP-X	IC		
R652	NRSA63J-222X	MG RESISTOR	2.2kΩ 1/16W J		IC922	BD9781HFP-W	IC		
R653	NRSA63J-103X	MG RESISTOR	10kΩ 1/16W J		IC961	SN74LVC32APW-X	IC		
R654	NRSA63J-103X	MG RESISTOR	10kΩ 1/16W J		IC962	SN74HCT32APW-X	IC		
R655	NRSA63J-103X	MG RESISTOR	10kΩ 1/16W J		Q4	2SA1365/F/-X	TRANSISTOR		
R656	NRSA63J-103X	MG RESISTOR	10kΩ 1/16W J		Q5	RT1N141C-X	DIGI TRANSISTOR		
R657	NRSA63J-513X	MG RESISTOR	51kΩ 1/16W J		Q7	2SA1530A/R/-X	TRANSISTOR		
R658	NRSA63J-184X	MG RESISTOR	180kΩ 1/16W J		Q11	RT1N141C-X	DIGI TRANSISTOR		
R660	NRSA02J-391X	MG RESISTOR	390Ω 1/10W J		Q14	RT1N141C-X	DIGI TRANSISTOR		
R661	NRSA02J-391X	MG RESISTOR	390Ω 1/10W J		Q14	RT1N141C-X	DIGI TRANSISTOR		
R670	NRSA63J-0R0X	MG RESISTOR	0Ω 1/16W J		Q31	RT1N141C-X	DIGI TRANSISTOR		
R672	NRSA02J-471X	MG RESISTOR	470Ω 1/10W J		Q161	RT1N141C-X	DIGI TRANSISTOR	DV6205U, DV6205UT, DV6205A, DV6206U, DV6206UT, DV6206A	
R673	NRSA02J-473X	MG RESISTOR	47kΩ 1/10W J		Q162	RT1N141C-X	DIGI TRANSISTOR	DV6205U, DV6205UT, DV6205A, DV6206U, DV6206UT, DV6206A	
R674	NRSA02J-102X	MG RESISTOR	1kΩ 1/10W J		Q191	KTD1304-X	TRANSISTOR	DV6205U, DV6205UT, DV6205A, DV6206U, DV6206UT, DV6206A	
R691	NRSA63J-103X	MG RESISTOR	10kΩ 1/16W J		Q192	RT1P441C-X	DIGI TRANSISTOR	DV6205U, DV6205UT, DV6205A, DV6206U, DV6206UT, DV6206A	
R692	NRSA63J-471X	MG RESISTOR	470Ω 1/16W J		Q301	RT1N441C-X	TRANSISTOR		

CN601	NNZ0085-001	CAR CONNECTOR			Q302	RT1P441C-X	DIGI TRANSISTOR		
EN601	QSW1115-002	ROTARY ENCODER			Q303	RT1N141C-X	DIGI TRANSISTOR		
J601	QNS0245-001	AUX JACK			Q304	RT1N141C-X	DIGI TRANSISTOR		
S601	NSW0206-001X	TACT SWITCH			Q324	KTD1304-X	TRANSISTOR	DV6205U, DV6205UT, DV6205A, DV6206U, DV6206UT, DV6206A	
S602	NSW0206-001X	TACT SWITCH			Q334	KTD1304-X	TRANSISTOR	DV6205U, DV6205UT, DV6205A, DV6206U, DV6206UT, DV6206A	
S603	NSW0206-001X	TACT SWITCH			Q344	KTD1304-X	TRANSISTOR	DV6205U, DV6205UT, DV6205A, DV6206U, DV6206UT, DV6206A	
S604	NSW0206-001X	TACT SWITCH			Q354	KTD1304-X	TRANSISTOR	DV6205U, DV6205UT, DV6205A, DV6206U, DV6206UT, DV6206A	
S605	NSW0206-001X	TACT SWITCH			Q421	KTD1304-X	TRANSISTOR	DV6205U, DV6205UT, DV6205A, DV6206U, DV6206UT, DV6206A	
S606	NSW0206-001X	TACT SWITCH			Q422	KTD1304-X	TRANSISTOR	DV6205U, DV6205UT, DV6205A, DV6206U, DV6206UT, DV6206A	
S607	NSW0206-001X	TACT SWITCH			Q431	KTD1304-X	TRANSISTOR	DV6205U, DV6205UT, DV6205A, DV6206U, DV6206UT, DV6206A	
S608	NSW0206-001X	TACT SWITCH			Q432	KTD1304-X	TRANSISTOR	DV6205U, DV6205UT, DV6205A, DV6206U, DV6206UT, DV6206A	
S609	NSW0206-001X	TACT SWITCH			Q432	KTD1304-X	TRANSISTOR	DV6205U, DV6205UT, DV6205A, DV6206U, DV6206UT, DV6206A	
S610	NSW0206-001X	TACT SWITCH			Q701	2SA1530A/R/-X	TRANSISTOR		
S611	NSW0206-001X	TACT SWITCH			Q781	RT1P141C-X	DIGI TRANSISTOR	DV6205U, DV6205UT, DV6205A, DV6206U, DV6206UT, DV6206A	
S612	NSW0206-001X	TACT SWITCH			Q782	RT1P141C-X	DIGI TRANSISTOR	DV6205U, DV6205UT, DV6205A, DV6206U, DV6206UT, DV6206A	
S613	NSW0206-001X	TACT SWITCH			Q783	RT1P141C-X	DIGI TRANSISTOR		
S614	NSW0206-001X	TACT SWITCH			Q821	RT1N141C-X	DIGI TRANSISTOR		
S616	NSW0206-001X	TACT SWITCH			Q822	RT1P141C-X	DIGI TRANSISTOR		
S617	NSW0206-001X	TACT SWITCH			Q823	2SD1994A/RS-T	TRANSISTOR		

**Main board
(KD-DV5205U, KD-DV5205UT,
KD-DV5206U, KD-DV5206UT,
KD-DV6205U, KD-DV6205UT,
KD-DV6205A, KD-DV6206U,
KD-DV6206UT, KD-DV6206A)**

Block No. [0][3]

△ Symbol No.	Part No.	Part Name	Description	Local	D1	MA111-X	SI DIODE		
△ IC31	TB2118F-X	PLL IC			D2	MA111-X	SI DIODE		
IC101	NJM4565V-X	IC	DV6205U, DV6205UT, DV6205A, DV6206U, DV6206UT, DV6206A		D3	MC2838-X	DIODE		
IC161	TDA7416	IC			D4	MA111-X	SI DIODE		
IC162	CD4066BPW-X	IC	DV6205U, DV6205UT, DV6205A, DV6206U, DV6206UT, DV6206A		D192	MA111-X	SI DIODE	DV6205U, DV6205UT, DV6205A, DV6206U, DV6206UT, DV6206A	
IC301	TB2906HQ	IC			D301	UDZS11B-X	Z DIODE		
IC371	NJM2160BV-X	IC	DV6205U, DV6205UT, DV6205A, DV6206U, DV6206UT, DV6206A		D302	MA111-X	SI DIODE		
IC381	NJM2160BV-X	IC	DV6205U, DV6205UT, DV6205A, DV6206U, DV6206UT, DV6206A		D305	CRS03-W	SB DIODE		
IC401	SN74AHCT1G08V-X	IC			D308	CRS03-W	SB DIODE		
IC402	TOTX177L	OPTICAL JACK			D324	MA111-X	SI DIODE	DV6205U, DV6205UT, DV6205A, DV6206U, DV6206UT, DV6206A	
IC411	MM1510XN-X	IC			D334	MA111-X	SI DIODE	DV6205U, DV6205UT, DV6205A, DV6206U, DV6206UT, DV6206A	
IC421	NJM4580V-X	IC	DV6205U, DV6205UT, DV6205A, DV6206U, DV6206UT, DV6206A		D344	MA111-X	SI DIODE		
IC431	LC75344M-X	IC	DV6205U, DV6205UT, DV6205A, DV6206U, DV6206UT, DV6206A		D354	MA111-X	SI DIODE		
					D401	CRS03-W	SB DIODE		
					D421	MA111-X	SI DIODE	DV6205U, DV6205UT, DV6205A, DV6206U, DV6206UT, DV6206A	
					D431	MA111-X	SI DIODE	DV6205U, DV6205UT, DV6205A, DV6206U, DV6206UT, DV6206A	
					D701	MA8062/M/-X	Z DIODE		

△ Symbol No.	Part No.	Part Name	Description	Local	△ Symbol No.	Part No.	Part Name	Description	Local
D702	MA8062/M-X	Z DIODE			C102	QEKJ1CM-226Z	E CAPACITOR	22uF 16V M	DV6205U, DV6205UT, DV6205A, DV6206U, DV6206UT, DV6206A
D703	MA8062/M-X	Z DIODE			C103	QEKJ0JM-476Z	E CAPACITOR	47uF 6.3V M	DV6205U, DV6205UT, DV6205A, DV6206U, DV6206UT, DV6206A
D704	MA8062/M-X	Z DIODE			C109	NCB31EK-223X	C CAPACITOR	0.022uF 25V K	DV6205U, DV6205UT, DV6205A, DV6206U, DV6206UT, DV6206A
D705	MA8062/M-X	Z DIODE			C110	QEKJ1CM-476Z	E CAPACITOR	47uF 16V M	DV6205U, DV6205UT, DV6205A, DV6206U, DV6206UT, DV6206A
D706	MA8062/M-X	Z DIODE			C111	QEKJ1CM-106Z	E CAPACITOR	10uF 16V M	DV6205U, DV6205UT, DV6205A, DV6206U, DV6206UT, DV6206A
D707	MA8062/M-X	Z DIODE			C112	QEKJ1CM-226Z	E CAPACITOR	22uF 16V M	DV6205U, DV6205UT, DV6205A, DV6206U, DV6206UT, DV6206A
D709	MA8062/M-X	Z DIODE			C113	QEKJ0JM-476Z	E CAPACITOR	47uF 6.3V M	DV6205U, DV6205UT, DV6205A, DV6206U, DV6206UT, DV6206A
D710	MA8062/M-X	Z DIODE			C155	NCB31AK-474X	C CAPACITOR	0.47uF 10V K	DV6205U, DV6205UT, DV6205A, DV6206U, DV6206UT, DV6206A
D711	MA8062/M-X	Z DIODE			C156	NCB31EK-473X	C CAPACITOR	0.047uF 25V K	DV6205U, DV6205UT, DV6205A, DV6206U, DV6206UT, DV6206A
D712	UDZW5.1B-X	SB DIODE		DV6205U, DV6205UT, DV6205A, DV6206U, DV6206UT, DV6206A	C161	QTE1A57-107Z	E CAPACITOR	100uF 10V	
D713	UDZW5.1B-X	SB DIODE		DV6205U, DV6205UT, DV6205A, DV6206U, DV6206UT, DV6206A	C162	NCB31CK-473X	C CAPACITOR	0.047uF 16V K	
D714	UDZW5.1B-X	SB DIODE		DV6205U, DV6205UT, DV6205A, DV6206U, DV6206UT, DV6206A	C163	NFV81CM-105X	MF CAPACITOR	1uF 16V M	
D715	UDZW5.1B-X	SB DIODE		DV6205U, DV6205UT, DV6205A, DV6206U, DV6206UT, DV6206A	C164	NFV81CM-105X	MF CAPACITOR	1uF 16V M	
D716	MA8062/M-X	Z DIODE			C165	NFV81CM-105X	MF CAPACITOR	1uF 16V M	
D717	MA8062/M-X	Z DIODE			C166	QTE1C57-106Z	E CAPACITOR	10uF 16V	
D719	SLR-56VC3F	DIODE C.M			C168	QEKJ1HM-225Z	E CAPACITOR	2.2uF 50V M	
D731	MA111-X	SI DIODE			C169	NCB31HK-103X	C CAPACITOR	0.01uF 50V K	DV6205U, DV6205UT, DV6205A, DV6206U, DV6206UT, DV6206A
D781	MC2836-X	DIODE			C170	QEKJ1CM-106Z	E CAPACITOR	10uF 16V M	
D782	MC2836-X	DIODE			C171	QTE1H57-225Z	E CAPACITOR	2.2uF 50V	
D783	UDZS11B-X	Z DIODE		DV6205U, DV6205UT, DV6206U, DV6206UT	C172	QTE1H55-225Z	E CAPACITOR	2.2uF 50V	
D783	UDZS9.1B-X	Z DIODE		DV6205U, DV6205UT, DV6205A, DV6206U, DV6206UT, DV6206A	C174	QEKJ1HM-225Z	E CAPACITOR	2.2uF 50V M	
D801	CRS03-W	SB DIODE			C175	NCB31HK-471X	C CAPACITOR	470pF 50V K	
D821	UDZS12B-X	Z DIODE			C176	QEKJ1HM-225Z	E CAPACITOR	2.2uF 50V M	DV6205U, DV6205UT, DV6205A, DV6206U, DV6206UT, DV6206A
D851	CRS03-W	SB DIODE			C177	QEKJ1HM-225Z	E CAPACITOR	2.2uF 50V M	
D852	CRS03-W	SB DIODE			C181	QTE1H57-225Z	E CAPACITOR	2.2uF 50V	
D885	MA111-X	SI DIODE			C182	QTE1H55-225Z	E CAPACITOR	2.2uF 50V	
D891	MC2836-X	DIODE			C184	QEKJ1HM-225Z	E CAPACITOR	2.2uF 50V M	
△ D901	1N5401-F64	SI DIODE			C185	NCB31HK-471X	C CAPACITOR	470pF 50V K	
D903	MA111-X	SI DIODE			C186	QEKJ1HM-225Z	E CAPACITOR	2.2uF 50V M	DV6205U, DV6205UT, DV6205A, DV6206U, DV6206UT, DV6206A
D906	UDZW5.1B-X	SB DIODE			C187	QEKJ1HM-225Z	E CAPACITOR	2.2uF 50V M	
D921	1A3G-T1	SI DIODE			C188	QEKJ1HM-225Z	E CAPACITOR	2.2uF 50V M	
D922	RB051L-40-X	SB DIODE			C191	QEKJ0JM-476Z	E CAPACITOR	47uF 6.3V M	DV6205U, DV6205UT, DV6205A, DV6206U, DV6206UT, DV6206A
D981	CRS03-W	SB DIODE			C267	QEKJ1CM-106Z	E CAPACITOR	10uF 16V M	DV6205U, DV6205UT, DV6205A, DV6206U, DV6206UT, DV6206A
D982	CRS03-W	SB DIODE			C301	QEKJ1CM-476Z	E CAPACITOR	47uF 16V M	
C2	NCB31HK-102X	C CAPACITOR	1000pF 50V K		C302	NCB31HK-103X	C CAPACITOR	0.01uF 50V K	
C3	NCB31HK-103X	C CAPACITOR	0.01uF 50V K		C311	NBE21CM-475X	TA E CAPACITOR	4.7uF 16V M	
C4	QEKJ1AM-227Z	E CAPACITOR	220uF 10V M		C312	QTE1C57-476Z	E CAPACITOR	47uF 16V	
C5	QEKJ1CM-476Z	E CAPACITOR	47uF 16V M		C313	NCB31HK-103X	C CAPACITOR	0.01uF 50V K	
C6	NCB31EK-473X	C CAPACITOR	0.047uF 25V K		C314	QEKJ1HM-225Z	E CAPACITOR	2.2uF 50V M	
C7	NCB31HK-103X	C CAPACITOR	0.01uF 50V K		C315	QEKJ1CM-226Z	E CAPACITOR	2.2uF 16V M	
C8	QEKJ1CM-226Z	E CAPACITOR	22uF 16V M		C316	NCB31HK-103X	C CAPACITOR	0.01uF 50V K	
C9	NCB31HK-103X	C CAPACITOR	0.01uF 50V K		C326	QEKJ1EM-475Z	E CAPACITOR	4.7uF 25V M	DV6205U, DV6205UT, DV6205A, DV6206U, DV6206UT, DV6206A
C12	QEKJ1HM-104Z	E CAPACITOR	0.1uF 50V M		C328	NFV81CM-105X	MF CAPACITOR	1uF 16V M	
C28	NCS31HJ-7R0X	C CAPACITOR	7pF 50V J		C329	NCS31HJ-101X	C CAPACITOR	100pF 50V J	
C29	NDC31HJ-100X	C CAPACITOR	10pF 50V J		C331	NCB31HK-223X	C CAPACITOR	0.022uF 50V K	
C30	NDC31HJ-100X	C CAPACITOR	10pF 50V J		C336	QEKJ1EM-475Z	E CAPACITOR	4.7uF 25V M	DV6205U, DV6205UT, DV6205A, DV6206U, DV6206UT, DV6206A
C31	NCB31HK-103X	C CAPACITOR	0.01uF 50V K		C338	NFV81CM-105X	MF CAPACITOR	1uF 16V M	
C32	NCB31HK-103X	C CAPACITOR	0.01uF 50V K		C339	NCS31HJ-101X	C CAPACITOR	100pF 50V J	
C33	NCB31HK-102X	C CAPACITOR	1000pF 50V K		C346	QEKJ1EM-475Z	E CAPACITOR	4.7uF 25V M	
C34	NCB31HK-103X	C CAPACITOR	0.01uF 50V K		C348	NFV81CM-105X	MF CAPACITOR	1uF 16V M	
C35	QFV61HJ-473Z	MF CAPACITOR	0.047uF 50V J		C349	NCS31HJ-101X	C CAPACITOR	100pF 50V J	
C36	NCB31HK-102X	C CAPACITOR	1000pF 50V K		C356	QEKJ1EM-475Z	E CAPACITOR	4.7uF 25V M	
C37	NCB31HK-272X	C CAPACITOR	2700pF 50V K		C358	NFV81CM-105X	MF CAPACITOR	1uF 16V M	
C38	NCB31HK-103X	C CAPACITOR	0.01uF 50V K		C359	NCS31HJ-101X	C CAPACITOR	100pF 50V J	
C39	NCS31HJ-101X	C CAPACITOR	100pF 50V J		C373	QEKJ1EM-475Z	E CAPACITOR	4.7uF 25V M	DV6205U, DV6205UT, DV6205A, DV6206U, DV6206UT, DV6206A
C40	NDC31HJ-470X	C CAPACITOR	47pF 50V J		C374	QEKJ1EM-475Z	E CAPACITOR	4.7uF 25V M	DV6205U, DV6205UT, DV6205A, DV6206U, DV6206UT, DV6206A
C41	QEKJ1CM-106Z	E CAPACITOR	10uF 16V M		C375	NCB31EK-104X	C CAPACITOR	0.1uF 25V K	DV6205U, DV6205UT, DV6205A, DV6206U, DV6206UT, DV6206A
C42	NCB31EK-473X	C CAPACITOR	0.047uF 25V K		C376	NCB31EK-104X	C CAPACITOR	0.1uF 25V K	DV6205U, DV6205UT, DV6205A, DV6206U, DV6206UT, DV6206A
C43	QEKJ1AM-227Z	E CAPACITOR	220uF 10V M		C377	NCB31HK-152X	C CAPACITOR	1500pF 50V K	DV6205U, DV6205UT, DV6205A, DV6206U, DV6206UT, DV6206A
C47	NCB31HK-103X	C CAPACITOR	0.01uF 50V K		C378	NCB31HK-152X	C CAPACITOR	1500pF 50V K	DV6205U, DV6205UT, DV6205A, DV6206U, DV6206UT, DV6206A
C48	NCS31HJ-470X	C CAPACITOR	47pF 50V J						
C50	NCS31HJ-101X	C CAPACITOR	100pF 50V J						
C51	NCS31HJ-331X	C CAPACITOR	330pF 50V J						
C82	NCB31HK-123X	C CAPACITOR	0.012uF 50V K						
C83	QTE1H57-105Z	E CAPACITOR	1uF 50V						
C84	NCB31HK-122X	C CAPACITOR	1200pF 50V K						
C92	NCB31HK-123X	C CAPACITOR	0.012uF 50V K						
C93	QTE1H57-105Z	E CAPACITOR	1uF 50V						
C94	NCB31HK-122X	C CAPACITOR	1200pF 50V K						
C99	QEKJ1CM-226Z	E CAPACITOR	22uF 16V M						
C101	QEKJ1CM-106Z	E CAPACITOR	10uF 16V M	DV6205U, DV6205UT, DV6205A, DV6206U, DV6206UT, DV6206A					

△ Symbol No.	Part No.	Part Name	Description	Local
C379	QEJ1AM-107Z	E CAPACITOR	100uF 10V M	DV6205U, DV6205UT, DV6205A, DV6206U, DV6206UT, DV6206A
C380	QEJ1AM-107Z	E CAPACITOR	100uF 10V M	DV6205U, DV6205UT, DV6205A, DV6206U, DV6206UT, DV6206A
C383	QEJ1EM-475Z	E CAPACITOR	4.7uF 25V M	DV6205U, DV6205UT, DV6205A, DV6206U, DV6206UT, DV6206A
C384	QEJ1EM-475Z	E CAPACITOR	4.7uF 25V M	DV6205U, DV6205UT, DV6205A, DV6206U, DV6206UT, DV6206A
C385	NCB31EK-104X	C CAPACITOR	0.1uF 25V K	DV6205U, DV6205UT, DV6205A, DV6206U, DV6206UT, DV6206A
C386	NCB31EK-104X	C CAPACITOR	0.1uF 25V K	DV6205U, DV6205UT, DV6205A, DV6206U, DV6206UT, DV6206A
C387	NCB31HK-152X	C CAPACITOR	1500pF 50V K	DV6205U, DV6205UT, DV6205A, DV6206U, DV6206UT, DV6206A
C388	NCB31HK-152X	C CAPACITOR	1500pF 50V K	DV6205U, DV6205UT, DV6205A, DV6206U, DV6206UT, DV6206A
C389	QEJ1AM-107Z	E CAPACITOR	100uF 10V M	DV6205U, DV6205UT, DV6205A, DV6206U, DV6206UT, DV6206A
C390	QEJ1AM-107Z	E CAPACITOR	100uF 10V M	DV6205U, DV6205UT, DV6205A, DV6206U, DV6206UT, DV6206A
C391	QEKJ0JM-476Z	E CAPACITOR	47uF 6.3V M	DV6205U, DV6205UT, DV6205A, DV6206U, DV6206UT, DV6206A
C392	QEKJ0JM-476Z	E CAPACITOR	47uF 6.3V M	DV6205U, DV6205UT, DV6205A, DV6206U, DV6206UT, DV6206A
C401	NCS31HJ-220X	C CAPACITOR	22pF 50V J	
C402	NCB31HK-103X	C CAPACITOR	0.01uF 50V K	
C403	NCB31HK-103X	C CAPACITOR	0.01uF 50V K	
C404	QEKJ0JM-107Z	E CAPACITOR	100uF 6.3V M	
C405	NCS31HJ-220X	C CAPACITOR	22pF 50V J	
C406	NCB31HK-103X	C CAPACITOR	0.01uF 50V K	
C411	QEJ1AM-227Z	E CAPACITOR	220uF 10V M	
C412	NCB31EK-473X	C CAPACITOR	0.047uF 25V K	
C413	QCZ0202-155Z	C CAPACITOR	1.5uF 25V Z	
C414	QERF0JM-337Z	E CAPACITOR	330uF 6.3V M	
C415	NCS31HJ-101X	C CAPACITOR	100pF 50V J	
C416	NCB31HK-103X	C CAPACITOR	0.01uF 50V K	
C422	NCB31EK-103X	C CAPACITOR	0.01uF 25V K	DV6205U, DV6205UT, DV6205A, DV6206U, DV6206UT, DV6206A
C423	QEJ1AM-227Z	E CAPACITOR	220uF 10V M	DV6205U, DV6205UT, DV6205A, DV6206U, DV6206UT, DV6206A
C424	NCS31HJ-151X	C CAPACITOR	150pF 50V J	DV6205U, DV6205UT, DV6205A, DV6206U, DV6206UT, DV6206A
C425	NCS31HJ-101X	C CAPACITOR	100pF 50V J	DV6205U, DV6205UT, DV6205A, DV6206U, DV6206UT, DV6206A
C426	NCS31HJ-221X	C CAPACITOR	220pF 50V J	DV6205U, DV6205UT, DV6205A, DV6206U, DV6206UT, DV6206A
C427	QEJ1EM-475Z	E CAPACITOR	4.7uF 25V M	DV6205U, DV6205UT, DV6205A, DV6206U, DV6206UT, DV6206A
C428	QEJ1EM-475Z	E CAPACITOR	4.7uF 25V M	DV6205U, DV6205UT, DV6205A, DV6206U, DV6206UT, DV6206A
C432	NCB31EK-103X	C CAPACITOR	0.01uF 25V K	DV6205U, DV6205UT, DV6205A, DV6206U, DV6206UT, DV6206A
C433	QEJ1AM-227Z	E CAPACITOR	220uF 10V M	DV6205U, DV6205UT, DV6205A, DV6206U, DV6206UT, DV6206A
C434	NCS31HJ-151X	C CAPACITOR	150pF 50V J	DV6205U, DV6205UT, DV6205A, DV6206U, DV6206UT, DV6206A
C435	NCS31HJ-101X	C CAPACITOR	100pF 50V J	DV6205U, DV6205UT, DV6205A, DV6206U, DV6206UT, DV6206A
C436	NCS31HJ-221X	C CAPACITOR	220pF 50V J	DV6205U, DV6205UT, DV6205A, DV6206U, DV6206UT, DV6206A
C437	QEJ1EM-475Z	E CAPACITOR	4.7uF 25V M	DV6205U, DV6205UT, DV6205A, DV6206U, DV6206UT, DV6206A
C438	QEJ1EM-475Z	E CAPACITOR	4.7uF 25V M	DV6205U, DV6205UT, DV6205A, DV6206U, DV6206UT, DV6206A
C441	QEKJ0JM-476Z	E CAPACITOR	47uF 6.3V M	DV6205U, DV6205UT, DV6205A, DV6206U, DV6206UT, DV6206A
C451	QEKJ0JM-476Z	E CAPACITOR	47uF 6.3V M	DV6205U, DV6205UT, DV6205A, DV6206U, DV6206UT, DV6206A
C461	QEKJ1CM-226Z	E CAPACITOR	22uF 16V M	DV6205U, DV6205UT, DV6205A, DV6206U, DV6206UT, DV6206A
C462	QEJ1AM-107Z	E CAPACITOR	100uF 10V M	DV6205U, DV6205UT, DV6205A, DV6206U, DV6206UT, DV6206A
C463	NCF31CZ-104X	C CAPACITOR	0.1uF 16V Z	DV6205U, DV6205UT, DV6205A, DV6206U, DV6206UT, DV6206A
C464	QEJ1AM-107Z	E CAPACITOR	100uF 10V M	DV6205U, DV6205UT, DV6205A, DV6206U, DV6206UT, DV6206A
C465	NCF31CZ-104X	C CAPACITOR	0.1uF 16V Z	DV6205U, DV6205UT, DV6205A, DV6206U, DV6206UT, DV6206A
C701	NCB31HK-103X	C CAPACITOR	0.01uF 50V K	
C702	NCB31CK-104X	C CAPACITOR	0.1uF 16V K	
C703	NDC31HJ-101X	C CAPACITOR	100pF 50V J	DV6205U, DV6205UT, DV6205A, DV6206U, DV6206UT, DV6206A

△ Symbol No.	Part No.	Part Name	Description	Local
C704	NCB31AK-474X	C CAPACITOR	0.47uF 10V K	DV6205U, DV6205UT, DV6205A, DV6206U, DV6206UT, DV6206A
C705	NDC31HJ-101X	C CAPACITOR	100pF 50V J	DV6205U, DV6205UT, DV6205A, DV6206U, DV6206UT, DV6206A
C721	NCB31EK-473X	C CAPACITOR	0.047uF 25V K	
C722	QEJ1AM-227Z	E CAPACITOR	220uF 10V M	
C723	NCS31HJ-471X	C CAPACITOR	470pF 50V J	
C724	NCS31HJ-471X	C CAPACITOR	470pF 50V J	
C725	QEJ1AM-227Z	E CAPACITOR	220uF 10V M	
C726	NDC31HJ-8R0X	C CAPACITOR	8pF 50V J	
C727	NDC31HJ-270X	C CAPACITOR	27pF 50V J	
C728	NDC31HJ-270X	C CAPACITOR	27pF 50V J	
C729	NDC31HJ-220X	C CAPACITOR	22pF 50V J	
C730	QEKJ0JM-476Z	E CAPACITOR	47uF 6.3V M	
C731	NCB31CK-103X	C CAPACITOR	0.01uF 16V K	
C732	QEJ1AM-227Z	E CAPACITOR	220uF 10V M	
C733	NCS31HJ-471X	C CAPACITOR	470pF 50V J	
C781	QEKJ0JM-476Z	E CAPACITOR	47uF 6.3V M	
C782	QEKJ0JM-476Z	E CAPACITOR	47uF 6.3V M	DV6205U, DV6205UT, DV6205A, DV6206U, DV6206UT, DV6206A
C783	QEJ1CM-476Z	E CAPACITOR	47uF 16V M	DV5205U, DV5205UT, DV5205A, DV5206U, DV5206UT, DV5206A
C783	QEJ1AM-227Z	E CAPACITOR	220uF 10V M	DV6205U, DV6205UT, DV6205A, DV6206U, DV6206UT, DV6206A
C802	NCS31HJ-220X	C CAPACITOR	22pF 50V J	
C803	NCB31CK-473X	C CAPACITOR	0.047uF 16V K	
C804	NCS31HJ-220X	C CAPACITOR	22pF 50V J	
C821	QEKJ1CM-106Z	E CAPACITOR	10uF 16V M	
C822	QEKJ1CM-106Z	E CAPACITOR	10uF 16V M	
C823	NCB31HK-103X	C CAPACITOR	0.01uF 50V K	
C851	NCB31CK-104X	C CAPACITOR	0.1uF 16V K	
C881	QEKJ1CM-226Z	E CAPACITOR	22uF 16V M	
C885	QEKJ1CM-106Z	E CAPACITOR	10uF 16V M	
C892	NCB31CK-104X	C CAPACITOR	0.1uF 16V K	
C901	QEZ0722-338	E CAPACITOR	3300uF	
C902	QEKJ1HM-225Z	E CAPACITOR	2.2uF 50V M	
C903	QEKJ1CM-106Z	E CAPACITOR	10uF 16V M	
C904	NCF31CZ-104X	C CAPACITOR	0.1uF 16V Z	
C905	QEJ1AM-107Z	E CAPACITOR	100uF 10V M	
C906	NCF31CZ-104X	C CAPACITOR	0.1uF 16V Z	
C907	NCB31HK-103X	C CAPACITOR	0.01uF 50V K	
C908	QEJ1AM-227Z	E CAPACITOR	220uF 10V M	
C909	QEKJ1CM-107Z	E CAPACITOR	100uF 16V M	
C910	NCB31HK-102X	C CAPACITOR	1000pF 50V K	
C911	NCB31HK-102X	C CAPACITOR	1000pF 50V K	
C912	QEKJ1CM-226Z	E CAPACITOR	22uF 16V M	
C913	NCB31EK-473X	C CAPACITOR	0.047uF 25V K	
C921	QEJ1AM-227Z	E CAPACITOR	220uF 10V M	
C922	QEJ1AM-107Z	E CAPACITOR	100uF 10V M	
C925	QEJ1AM-227Z	E CAPACITOR	220uF 10V M	
C926	QEXF1AM-476Z	E CAPACITOR	47uF 10V M	
C927	QEZ0595-477Z	E CAPACITOR	470uF	
C928	NCF31CZ-104X	C CAPACITOR	0.1uF 16V Z	
C929	NCB31HK-472X	C CAPACITOR	4700pF 50V K	
C930	NCF31CZ-104X	C CAPACITOR	0.1uF 16V Z	
C961	QEKJ1AM-227Z	E CAPACITOR	220uF 10V M	
C962	QEJ1AM-227Z	E CAPACITOR	220uF 10V M	
C963	QEJ1AM-227Z	E CAPACITOR	220uF 10V M	
C964	QEJ1AM-227Z	E CAPACITOR	220uF 10V M	
C965	QEJ1AM-227Z	E CAPACITOR	220uF 10V M	
C966	NCB31CK-104X	C CAPACITOR	0.1uF 16V K	
C967	NCB31CK-104X	C CAPACITOR	0.1uF 16V K	
C968	NCB31EK-473X	C CAPACITOR	0.047uF 25V K	
C969	NCB31EK-473X	C CAPACITOR	0.047uF 25V K	
C981	NCB31CK-104X	C CAPACITOR	0.1uF 16V K	
C997	NCB31HK-103X	C CAPACITOR	0.01uF 50V K	
C999	NCS31HJ-101X	C CAPACITOR	100pF 50V J	
R1	NRSA63J-473X	MG RESISTOR	47kΩ 1/16W J	
R2	NRS181J-220X	MG RESISTOR	22Ω 1/8W J	
R3	NRS181J-220X	MG RESISTOR	22Ω 1/8W J	
R4	NRSA63J-473X	MG RESISTOR	47kΩ 1/16W J	
R5	NRSA63J-472X	MG RESISTOR	4.7kΩ 1/16W J	
R6	NRSA63J-332X	MG RESISTOR	3.3kΩ 1/16W J	
R7	NRSA63J-473X	MG RESISTOR	47kΩ 1/16W J	
R8	NRS181J-0R0X	MG RESISTOR	0Ω 1/8W J	
R9	NRSA63J-100X	MG RESISTOR	10Ω 1/16W J	
R10	NRSA63J-273X	MG RESISTOR	27kΩ 1/16W J	
R12	NRSA63J-0R0X	MG RESISTOR	0Ω 1/16W J	

△ Symbol No.	Part No.	Part Name	Description	Local	△ Symbol No.	Part No.	Part Name	Description	Local
R416	NRSA63J-0R0X	MG RESISTOR	0Ω 1/16W J		R730	NRSA63J-222X	MG RESISTOR	2.2kΩ 1/16W J	DV6205U, DV6205UT, DV6205A, DV6206U, DV6206UT, DV6206A
R417	NRSA63D-181X	MG RESISTOR	180Ω 1/16W D		R732	NRSA63J-222X	MG RESISTOR	2.2kΩ 1/16W J	
R421	NRSA63J-220X	MG RESISTOR	22Ω 1/16W J	DV6205U, DV6205UT, DV6205A, DV6206U, DV6206UT, DV6206A	R733	NRSA63J-103X	MG RESISTOR	10kΩ 1/16W J	
R422	NRSA63J-102X	MG RESISTOR	1kΩ 1/16W J	DV6205U, DV6205UT, DV6205A, DV6206U, DV6206UT, DV6206A	R735	NRSA63J-0R0X	MG RESISTOR	0Ω 1/16W J	
R423	NRSA63J-102X	MG RESISTOR	1kΩ 1/16W J	DV6205U, DV6205UT, DV6205A, DV6206U, DV6206UT, DV6206A	R736	NRSA63J-222X	MG RESISTOR	2.2kΩ 1/16W J	
R424	NRSA63J-390X	MG RESISTOR	39Ω 1/16W J	DV6205U, DV6205UT, DV6205A, DV6206U, DV6206UT, DV6206A	R737	NRSA63J-222X	MG RESISTOR	2.2kΩ 1/16W J	
R425	NRSA63J-102X	MG RESISTOR	1kΩ 1/16W J	DV6205U, DV6205UT, DV6205A, DV6206U, DV6206UT, DV6206A	R738	NRSA63J-472X	MG RESISTOR	4.7kΩ 1/16W J	
R426	NRSA63J-183X	MG RESISTOR	18kΩ 1/16W J	DV6205U, DV6205UT, DV6205A, DV6206U, DV6206UT, DV6206A	R739	NRSA63J-472X	MG RESISTOR	4.7kΩ 1/16W J	
R427	NRSA63J-682X	MG RESISTOR	6.8kΩ 1/16W J	DV6205U, DV6205UT, DV6205A, DV6206U, DV6206UT, DV6206A	R740	NRSA63J-222X	MG RESISTOR	2.2kΩ 1/16W J	
R428	NRSA63J-472X	MG RESISTOR	4.7kΩ 1/16W J	DV6205U, DV6205UT, DV6205A, DV6206U, DV6206UT, DV6206A	R743	NRSA63J-473X	MG RESISTOR	47kΩ 1/16W J	
R429	NRSA63J-104X	MG RESISTOR	100kΩ 1/16W J	DV6205U, DV6205UT, DV6205A, DV6206U, DV6206UT, DV6206A	R744	NRSA63J-821X	MG RESISTOR	820Ω 1/16W J	
R431	NRSA63J-220X	MG RESISTOR	22Ω 1/16W J	DV6205U, DV6205UT, DV6205A, DV6206U, DV6206UT, DV6206A	R745	NRSA63J-106X	MG RESISTOR	10MΩ 1/16W J	
R432	NRSA63J-102X	MG RESISTOR	1kΩ 1/16W J	DV6205U, DV6205UT, DV6205A, DV6206U, DV6206UT, DV6206A	R746	NRSA63J-473X	MG RESISTOR	47kΩ 1/16W J	
R433	NRSA63J-102X	MG RESISTOR	1kΩ 1/16W J	DV6205U, DV6205UT, DV6205A, DV6206U, DV6206UT, DV6206A	R747	NRSA63J-473X	MG RESISTOR	47kΩ 1/16W J	DV6205A, DV6206A
R434	NRSA63J-390X	MG RESISTOR	39Ω 1/16W J	DV6205U, DV6205UT, DV6205A, DV6206U, DV6206UT, DV6206A	R749	NRSA63J-473X	MG RESISTOR	47kΩ 1/16W J	DV5205U, DV5205UT, DV5206U, DV5206UT, DV6206U, DV6206UT
R435	NRSA63J-102X	MG RESISTOR	1kΩ 1/16W J	DV6205U, DV6205UT, DV6205A, DV6206U, DV6206UT, DV6206A	R750	NRSA63J-473X	MG RESISTOR	47kΩ 1/16W J	
R436	NRSA63J-183X	MG RESISTOR	18kΩ 1/16W J	DV6205U, DV6205UT, DV6205A, DV6206U, DV6206UT, DV6206A	R751	NRSA63J-333X	MG RESISTOR	33kΩ 1/16W J	
R437	NRSA63J-682X	MG RESISTOR	6.8kΩ 1/16W J	DV6205U, DV6205UT, DV6205A, DV6206U, DV6206UT, DV6206A	R755	NRSA63J-103X	MG RESISTOR	10kΩ 1/16W J	
R438	NRSA63J-472X	MG RESISTOR	4.7kΩ 1/16W J	DV6205U, DV6205UT, DV6205A, DV6206U, DV6206UT, DV6206A	R756	NRSA63J-222X	MG RESISTOR	2.2kΩ 1/16W J	
R439	NRSA63J-104X	MG RESISTOR	100kΩ 1/16W J	DV6205U, DV6205UT, DV6205A, DV6206U, DV6206UT, DV6206A	R757	NRSA63J-473X	MG RESISTOR	47kΩ 1/16W J	
R441	NRSA63J-223X	MG RESISTOR	22kΩ 1/16W J	DV6205U, DV6205UT, DV6205A, DV6206U, DV6206UT, DV6206A	R758	NRSA63J-224X	MG RESISTOR	220kΩ 1/16W J	
R442	NRSA63J-223X	MG RESISTOR	22kΩ 1/16W J	DV6205U, DV6205UT, DV6205A, DV6206U, DV6206UT, DV6206A	R759	NRSA63J-224X	MG RESISTOR	220kΩ 1/16W J	
R451	NRSA63J-223X	MG RESISTOR	22kΩ 1/16W J	DV6205U, DV6205UT, DV6205A, DV6206U, DV6206UT, DV6206A	R760	NRSA63J-472X	MG RESISTOR	4.7kΩ 1/16W J	
R452	NRSA63J-223X	MG RESISTOR	22kΩ 1/16W J	DV6205U, DV6205UT, DV6205A, DV6206U, DV6206UT, DV6206A	R761	NRSA63J-472X	MG RESISTOR	4.7kΩ 1/16W J	
R461	NRSA63J-100X	MG RESISTOR	10Ω 1/16W J	DV6205U, DV6205UT, DV6205A, DV6206U, DV6206UT, DV6206A	R762	NRSA63J-472X	MG RESISTOR	4.7kΩ 1/16W J	
R462	NRSA63J-100X	MG RESISTOR	10Ω 1/16W J	DV6205U, DV6205UT, DV6205A, DV6206U, DV6206UT, DV6206A	R763	NRSA63J-103X	MG RESISTOR	10kΩ 1/16W J	
R463	NRSA63J-100X	MG RESISTOR	10Ω 1/16W J	DV6205U, DV6205UT, DV6205A, DV6206U, DV6206UT, DV6206A	R765	NRSA63J-103X	MG RESISTOR	10kΩ 1/16W J	
R701	NRSA63J-0R0X	MG RESISTOR	0Ω 1/16W J	DV6205U, DV6205UT, DV6205A, DV6206U, DV6206UT, DV6206A	R766	NRSA63J-473X	MG RESISTOR	47kΩ 1/16W J	
R702	NRSA63J-0R0X	MG RESISTOR	0Ω 1/16W J	DV6205U, DV6205UT, DV6205A, DV6206U, DV6206UT, DV6206A	R768	NRSA63J-103X	MG RESISTOR	10kΩ 1/16W J	
R703	NRSA63J-0R0X	MG RESISTOR	0Ω 1/16W J	DV6205U, DV6205UT, DV6205A, DV6206U, DV6206UT, DV6206A	R769	NRSA63J-473X	MG RESISTOR	47kΩ 1/16W J	
R704	NRSA63J-271X	MG RESISTOR	270Ω 1/16W J		R770	NRSA63J-102X	MG RESISTOR	1kΩ 1/16W J	
R705	NRSA63J-271X	MG RESISTOR	270Ω 1/16W J		R771	NRSA63J-392X	MG RESISTOR	3.9kΩ 1/16W J	
R706	NRSA63J-103X	MG RESISTOR	10kΩ 1/16W J		R772	NRSA63J-392X	MG RESISTOR	3.9kΩ 1/16W J	
R707	NRSA63J-103X	MG RESISTOR	10kΩ 1/16W J		R773	NRSA63J-392X	MG RESISTOR	3.9kΩ 1/16W J	
R708	NRS181J-331X	MG RESISTOR	330Ω 1/8W J		R774	NRSA63J-472X	MG RESISTOR	4.7kΩ 1/16W J	
R709	NRSA63J-562X	MG RESISTOR	5.6kΩ 1/16W J		R775	NRSA63J-472X	MG RESISTOR	4.7kΩ 1/16W J	
R710	NRSA63J-102X	MG RESISTOR	1kΩ 1/16W J		R776	NRSA63J-472X	MG RESISTOR	4.7kΩ 1/16W J	
R711	NRSA63J-103X	MG RESISTOR	10kΩ 1/16W J		R777	NRSA63J-102X	MG RESISTOR	1kΩ 1/16W J	
R712	NRSA63J-104X	MG RESISTOR	100kΩ 1/16W J		R779	NRSA63J-222X	MG RESISTOR	2.2kΩ 1/16W J	
R713	NRSA63J-103X	MG RESISTOR	10kΩ 1/16W J		R780	NRSA63J-222X	MG RESISTOR	2.2kΩ 1/16W J	
R714	NRSA63J-104X	MG RESISTOR	100kΩ 1/16W J		R781	NRSA63J-471X	MG RESISTOR	470Ω 1/16W J	
R715	NRSA63J-271X	MG RESISTOR	270Ω 1/16W J		R782	NRSA63J-471X	MG RESISTOR	470Ω 1/16W J	DV6205U, DV6205UT, DV6205A, DV6206U, DV6206UT, DV6206A
R716	NRSA63J-271X	MG RESISTOR	270Ω 1/16W J		R784	NRSA63J-222X	MG RESISTOR	2.2kΩ 1/16W J	DV5205U, DV5205UT, DV5206U, DV5206UT
R717	NRSA63J-103X	MG RESISTOR	10kΩ 1/16W J	DV6205U, DV6205UT, DV6205A, DV6206U, DV6206UT, DV6206A	R799	NRSA63J-222X	MG RESISTOR	2.2kΩ 1/16W J	
R718	NRSA63J-103X	MG RESISTOR	10kΩ 1/16W J		R801	NRSA63J-101X	MG RESISTOR	100Ω 1/16W J	
R719	NRSA63J-102X	MG RESISTOR	1kΩ 1/16W J		R802	NRSA63J-473X	MG RESISTOR	47kΩ 1/16W J	
R721	NRSA63J-222X	MG RESISTOR	2.2kΩ 1/16W J		R803	NRSA63J-223X	MG RESISTOR	22kΩ 1/16W J	
R722	NRSA63J-222X	MG RESISTOR	2.2kΩ 1/16W J		R804	NRSA63J-104X	MG RESISTOR	100kΩ 1/16W J	
R725	NRSA63J-473X	MG RESISTOR	47kΩ 1/16W J		R805	NRSA63J-103X	MG RESISTOR	10kΩ 1/16W J	
R726	NRSA63J-103X	MG RESISTOR	10kΩ 1/16W J		R806	NRSA63J-104X	MG RESISTOR	100kΩ 1/16W J	
R727	NRSA63J-562X	MG RESISTOR	5.6kΩ 1/16W J		R807	NRSA63J-331X	MG RESISTOR	330Ω 1/16W J	
R728	NRSA63J-472X	MG RESISTOR	4.7kΩ 1/16W J		R808	NRSA63J-223X	MG RESISTOR	22kΩ 1/16W J	
R729	NRSA63J-0R0X	MG RESISTOR	0Ω 1/16W J		R809	NRSA63J-101X	MG RESISTOR	100Ω 1/16W J	
					R810	NRSA63J-473X	MG RESISTOR	47kΩ 1/16W J	
					R821	NRSA63J-100X	MG RESISTOR	10Ω 1/16W J	
					R822	NRSA63J-471X	MG RESISTOR	470Ω 1/16W J	
					R841	NRSA63J-473X	MG RESISTOR	47kΩ 1/16W J	DV5205U, DV5205UT, DV5206U, DV5206UT
					R842	NRSA63J-473X	MG RESISTOR	47kΩ 1/16W J	DV6205U, DV6205UT, DV6205A, DV6206U, DV6206UT, DV6206A
					R843	NRSA63J-473X	MG RESISTOR	47kΩ 1/16W J	DV6205A, DV6206A
					R844	NRSA63J-473X	MG RESISTOR	47kΩ 1/16W J	DV5205U, DV5205UT, DV5206U, DV5206UT
					R851	NRSA63J-472X	MG RESISTOR	4.7kΩ 1/16W J	
					R881	NRSA63J-473X	MG RESISTOR	47kΩ 1/16W J	
					R882	NRSA63J-103X	MG RESISTOR	10kΩ 1/16W J	
					R883	NRSA63J-104X	MG RESISTOR	100kΩ 1/16W J	
					R885	NRSA63J-473X	MG RESISTOR	47kΩ 1/16W J	
					R886	NRSA63J-472X	MG RESISTOR	4.7kΩ 1/16W J	
					R887	NRSA63J-103X	MG RESISTOR	10kΩ 1/16W J	
					R888	NRSA63J-0R0X	MG RESISTOR	0Ω 1/16W J	
					R889	NRSA63J-0R0X	MG RESISTOR	0Ω 1/16W J	
					R891	NRSA63J-473X	MG RESISTOR	47kΩ 1/16W J	

△ Symbol No.	Part No.	Part Name	Description	Local
R892	NRSA63J-102X	MG RESISTOR	1kΩ 1/16W J	
R894	NRSA63J-0R0X	MG RESISTOR	0Ω 1/16W J	
R901	QRE142J-102X	C RESISTOR	1kΩ 1/4W J	
R902	NRSA63J-912X	MG RESISTOR	9.1kΩ 1/16W J	
R903	NRSA63J-472X	MG RESISTOR	4.7kΩ 1/16W J	
R909	NRSA63J-473X	MG RESISTOR	47kΩ 1/16W J	
R910	NRSA63J-222X	MG RESISTOR	2.2kΩ 1/16W J	
R914	NRS181J-221X	MG RESISTOR	220Ω 1/8W J	
R921	NRS181J-0R0X	MG RESISTOR	0Ω 1/8W J	
R923	NRSA63J-393X	MG RESISTOR	39kΩ 1/16W J	
R924	NRSA63J-103X	MG RESISTOR	10kΩ 1/16W J	
R925	NRSA63J-154X	MG RESISTOR	150kΩ 1/16W J	
R926	NRSA63J-394X	MG RESISTOR	390kΩ 1/16W J	
R927	NRSA63J-0R0X	MG RESISTOR	0Ω 1/16W J	
R928	NRSA63J-473X	MG RESISTOR	47kΩ 1/16W J	
R961	NRS181J-0R0X	MG RESISTOR	0Ω 1/8W J	
R962	NRSA63J-101X	MG RESISTOR	100Ω 1/16W J	
R967	NRS181J-0R0X	MG RESISTOR	0Ω 1/8W J	
R968	NRS181J-0R0X	MG RESISTOR	0Ω 1/8W J	
R969	NRS181J-0R0X	MG RESISTOR	0Ω 1/8W J	
R973	NRSA63J-103X	MG RESISTOR	10kΩ 1/16W J	
R974	NRSA63J-103X	MG RESISTOR	10kΩ 1/16W J	
R975	NRSA63J-103X	MG RESISTOR	10kΩ 1/16W J	
R976	NRSA63J-563X	MG RESISTOR	56kΩ 1/16W J	
R977	NRSA63J-183X	MG RESISTOR	18kΩ 1/16W J	
R981	NRS181J-222X	MG RESISTOR	2.2kΩ 1/8W J	
R982	NRS181J-222X	MG RESISTOR	2.2kΩ 1/8W J	
RA31	NRZ0065-222X	NET RESISTOR	2.2kΩ	
RA721	NRZ0065-222X	NET RESISTOR	2.2kΩ	DV6205U,DV6205UT,DV6205A, DV6206U,DV6206UT,DV6206A
RA723	NRZ0065-103X	NET RESISTOR	10kΩ 1/16W J	
L1	NQL334J-4R7X	COIL	4.7uH J	
L31	NQL114K-470X	INDUCTOR	47uH K	
L401	NQR0007-002X	FERRITE BEADS		
L411	NQL114K-470X	INDUCTOR	47uH K	
L421	NQR0007-002X	FERRITE BEADS		DV6205U,DV6205UT,DV6205A, DV6206U,DV6206UT,DV6206A
L430	NQR0007-002X	FERRITE BEADS		DV6205U,DV6205UT,DV6205A, DV6206U,DV6206UT,DV6206A
L431	NQR0007-002X	FERRITE BEADS		DV6205U,DV6205UT,DV6205A, DV6206U,DV6206UT,DV6206A
L721	NQL38DK-330X	COIL	33uH K	
L722	NQL114K-470X	INDUCTOR	47uH K	
L901	QQR1378-002	COIL		
L902	NQL56CK-220X	COIL	22uH K	
L924	NQL56CK-220X	COIL	22uH K	
L925	NQL71EM-330X	COIL	33uH M	
L927	NQLB7GM-100X	COIL	10uH M	
CN141	QGA2006C1-04	CONNECTOR	W-B (1-4)	
CN191	QGA2501C3-03Z	CONNECTOR	W-B (1-3)	DV6205U,DV6205UT,DV6205A, DV6206U,DV6206UT,DV6206A
CN411	QGA2501F1-02	CONNECTOR	W-B (1-2)	
CN421	QGA2501C3-03Z	CONNECTOR	W-B (1-3)	DV6205U,DV6205UT,DV6205A, DV6206U,DV6206UT,DV6206A
CN701	QNZ0605-001	CAR CONNECTOR		
CN821	QGA2001C1-02	CONNECTOR	W-B (1-2)	
CN901	QNZ0607-001	CAR CONNECTOR		
CN961	QGB2027M3-30S	CONNECTOR	B-B (1-30)	
CN962	QGF0534F3-45X	CONNECTOR	FFC/FPC (1-45)	
CN963	QGB2027L9-30X	CONNECTOR	B-B (1-30)	
J331	QNN0519-001	PIN JACK		DV6205U,DV6205UT,DV6206U, DV6206UT
J331	QNN0489-001	PIN JACK		DV6205U,DV6205UT,DV6205A, DV6206U,DV6206UT,DV6206A
J801	QNZ0095-001	CONNECTOR		
K401	NQR0007-002X	FERRITE BEADS		
K402	NQR0007-002X	FERRITE BEADS		
K411	NQR0201-004X	FERRITE BEADS		
K922	NQR0201-004X	FERRITE BEADS		
PP1	QZW0010-001	STYLE PIN		DV6205U,DV6205UT,DV6205A, DV6206U,DV6206UT,DV6206A
PP2	QZW0010-001	STYLE PIN		
S701	QSW0451-001	DETECT SW		
S702	QSW0451-001	DETECT SW		
S723	QSW1049-001Z	TACT SW		
TH721	NAD0028-103X	N THERMISTOR	10kΩ	
TU21	QAU0312-002	TUNER PACK		

△ Symbol No.	Part No.	Part Name	Description	Local
W21	QAM0105-003	CAR CABLE		
X31	QAX0616-001Z	CRYSTAL	10.250MHz	
X721	QAX0617-001Z	CRYSTAL	12.500MHz	
X722	QAX0401-001	CRYSTAL	32.768KHz	

**Switch board
(KD-DV5205U,KD-DV5205UT,
KD-DV5206U,KD-DV5206UT,
KD-DV6205U,KD-DV6205UT,
KD-DV6205A,KD-DV6206U,
KD-DV6206UT,KD-DV6206A)**

Block No. [0][4]

△ Symbol No.	Part No.	Part Name	Description	Local
IC601	PT6523LQ-L	LCD DRIVER		
IC602	RPM7338-V4	RM.RECEIVER		
Q640	2SA1365/F/-X	TRANSISTOR		
Q641	RT1N141C-X	DIGI TRANSISTOR		
D601	SML-310VT/JK/-X	LED		
D602	SML-310VT/JK/-X	LED		
D603	SML-310VT/JK/-X	LED		
D604	SML-310VT/JK/-X	LED		
D605	SML-310VT/JK/-X	LED		
D606	SML-310VT/JK/-X	LED		
D607	SML-310VT/JK/-X	LED		
D608	SML-310VT/JK/-X	LED		DV5205U,DV5205UT,DV5206U, DV5206UT
D608	SML310BA1T/HJ-X	LED		DV6205U,DV6205UT,DV6205A, DV6206U,DV6206UT,DV6206A
D609	SML-310VT/JK/-X	LED		DV5205U,DV5205UT,DV5206U, DV5206UT
D609	SML310BA1T/HJ-X	LED		DV6205U,DV6205UT,DV6205A, DV6206U,DV6206UT,DV6206A
D610	SML-310VT/JK/-X	LED		
D611	SML-310VT/JK/-X	LED		
D612	SML-310VT/JK/-X	LED		
D613	SML-310VT/JK/-X	LED		
D614	SML-310VT/JK/-X	LED		
D615	SML-310VT/JK/-X	LED		
D616	SML-310VT/JK/-X	LED		
D617	SML-310VT/JK/-X	LED		
D618	SML-310VT/JK/-X	LED		
D619	SML-310VT/JK/-X	LED		
D640	MC2838-X	DIODE		
D641	UDZW5.1B-X	SB DIODE		
D642	MA111-X	SI DIODE		
D643	MA8062/M/-X	Z DIODE		
D645	NSPW310BS/B2RST	LED		
D646	NSPW310BS/B2RST	LED		
C601	NCB31HK-223X	C CAPACITOR	0.022uF 50V K	
C602	NCS31HJ-681X	C CAPACITOR	680pF 50V J	
C603	NBE20JM-106X	TA E CAPACITOR	10uF 6.3V M	
C611	NCB31HK-123X	C CAPACITOR	0.012uF 50V K	
C612	NBE20JM-475X	TA E CAPACITOR	4.7uF 6.3V M	
C620	NCB31HK-473X	C CAPACITOR	0.047uF 50V K	DV6205U,DV6205UT,DV6205A, DV6206U,DV6206UT,DV6206A
R601	NRSA63J-821X	MG RESISTOR	820Ω 1/16W J	
R602	NRSA63J-821X	MG RESISTOR	820Ω 1/16W J	
R603	NRSA63J-122X	MG RESISTOR	1.2kΩ 1/16W J	
R604	NRSA63J-182X	MG RESISTOR	1.8kΩ 1/16W J	
R605	NRSA63J-272X	MG RESISTOR	2.7kΩ 1/16W J	
R606	NRSA63J-392X	MG RESISTOR	3.9kΩ 1/16W J	

△ Symbol No.	Part No.	Part Name	Description	Local
R607	NRSA63J-821X	MG RESISTOR	820Ω 1/16W J	
R608	NRSA63J-821X	MG RESISTOR	820Ω 1/16W J	
R609	NRSA63J-122X	MG RESISTOR	1.2kΩ 1/16W J	
R610	NRSA63J-182X	MG RESISTOR	1.8kΩ 1/16W J	
R611	NRSA63J-272X	MG RESISTOR	2.7kΩ 1/16W J	
R612	NRSA63J-392X	MG RESISTOR	3.9kΩ 1/16W J	
R613	NRSA63J-821X	MG RESISTOR	820Ω 1/16W J	
R614	NRSA63J-821X	MG RESISTOR	820Ω 1/16W J	
R620	NRSA63J-0R0X	MG RESISTOR	0Ω 1/16W J	DV6205U, DV6205UT, DV6205A, DV6206U, DV6206UT, DV6206A
R621	NRSA63J-0R0X	MG RESISTOR	0Ω 1/16W J	DV6205U, DV6205UT, DV6205A, DV6206U, DV6206UT, DV6206A
R622	NRSA63J-473X	MG RESISTOR	47kΩ 1/16W J	DV6205U, DV6205UT, DV6205A, DV6206U, DV6206UT, DV6206A
R623	NRSA63J-473X	MG RESISTOR	47kΩ 1/16W J	DV6205U, DV6205UT, DV6205A, DV6206U, DV6206UT, DV6206A
R624	NRSA63J-471X	MG RESISTOR	470Ω 1/16W J	DV6205U, DV6205UT, DV6205A, DV6206U, DV6206UT, DV6206A
R630	NRSA63J-122X	MG RESISTOR	1.2kΩ 1/16W J	DV5205U, DV5205UT, DV5206U, DV5206UT, DV6206A
R630	NRSA63J-102X	MG RESISTOR	1kΩ 1/16W J	DV6205U, DV6205UT, DV6205A, DV5205U, DV5205UT, DV5206U, DV5206UT, DV6206A
R631	NRSA63J-122X	MG RESISTOR	1.2kΩ 1/16W J	DV5206U, DV5206UT, DV6206U, DV6206UT, DV6206A
R632	NRSA63J-122X	MG RESISTOR	1.2kΩ 1/16W J	DV5205U, DV5205UT, DV5206U, DV5206UT, DV6206A
R632	NRSA63J-821X	MG RESISTOR	820Ω 1/16W J	DV6205U, DV6205UT, DV6205A, DV5205U, DV5205UT, DV5206U, DV5206UT, DV6206A
R633	NRSA63J-122X	MG RESISTOR	1.2kΩ 1/16W J	DV5206U, DV5206UT, DV6206U, DV6206UT, DV6206A
R634	NRSA63J-271X	MG RESISTOR	270Ω 1/16W J	DV5205U, DV5205UT, DV5206U, DV5206UT, DV6206A
R634	NRSA63J-331X	MG RESISTOR	330Ω 1/16W J	DV6205U, DV6205UT, DV6205A, DV5205U, DV5205UT, DV5206U, DV5206UT, DV6206A
R636	NRSA63J-271X	MG RESISTOR	270Ω 1/16W J	DV5206U, DV5206UT, DV6206U, DV6206UT, DV6206A
R636	NRSA63J-331X	MG RESISTOR	330Ω 1/16W J	DV6205U, DV6205UT, DV6205A
R638	NRSA63J-471X	MG RESISTOR	470Ω 1/16W J	
R640	NRSA02J-331X	MG RESISTOR	330Ω 1/10W J	
R641	NRSA02J-391X	MG RESISTOR	390Ω 1/10W J	DV5205U, DV5205UT, DV5206U, DV5206UT
R641	NRSA02J-121X	MG RESISTOR	120Ω 1/10W J	DV6205U, DV6205UT, DV6205A, DV6206U, DV6206UT, DV6206A
R642	NRSA02J-331X	MG RESISTOR	330Ω 1/10W J	
R643	NRSA02J-391X	MG RESISTOR	390Ω 1/10W J	DV5205U, DV5205UT, DV5206U, DV5206UT
R643	NRSA02J-201X	MG RESISTOR	200Ω 1/10W J	DV6205U, DV6205UT, DV6205A, DV6206U, DV6206UT, DV6206A
R644	NRSA63J-471X	MG RESISTOR	470Ω 1/16W J	
R646	NRSA63J-471X	MG RESISTOR	470Ω 1/16W J	
R648	NRSA63J-271X	MG RESISTOR	270Ω 1/16W J	DV5205U, DV5205UT, DV5206U, DV5206UT, DV6206A
R648	NRSA63J-331X	MG RESISTOR	330Ω 1/16W J	DV6205U, DV6205UT, DV6205A
R651	NRSA63J-222X	MG RESISTOR	2.2kΩ 1/16W J	
R652	NRSA63J-222X	MG RESISTOR	2.2kΩ 1/16W J	
R653	NRSA63J-103X	MG RESISTOR	10kΩ 1/16W J	
R654	NRSA63J-103X	MG RESISTOR	10kΩ 1/16W J	
R655	NRSA63J-103X	MG RESISTOR	10kΩ 1/16W J	
R656	NRSA63J-103X	MG RESISTOR	10kΩ 1/16W J	
R657	NRSA63J-513X	MG RESISTOR	51kΩ 1/16W J	
R658	NRSA63J-184X	MG RESISTOR	180kΩ 1/16W J	
R660	NRSA02J-391X	MG RESISTOR	390Ω 1/10W J	
R661	NRSA02J-391X	MG RESISTOR	390Ω 1/10W J	
R670	NRSA63J-0R0X	MG RESISTOR	0Ω 1/16W J	
R672	NRSA02J-471X	MG RESISTOR	470Ω 1/10W J	
R673	NRSA02J-473X	MG RESISTOR	47kΩ 1/10W J	
R674	NRSA02J-102X	MG RESISTOR	1kΩ 1/10W J	
R691	NRSA63J-103X	MG RESISTOR	10kΩ 1/16W J	
R692	NRSA63J-471X	MG RESISTOR	470Ω 1/16W J	
CN601	NNZ0085-001	CAR CONNECTOR		
EN601	QSW1115-002	ROTARY ENCODER		
J601	QNS0245-001	AUX JACK		DV6205U, DV6205UT, DV6205A, DV6206U, DV6206UT, DV6206A
S601	NSW0206-001X	TACT SWITCH		
S602	NSW0206-001X	TACT SWITCH		
S603	NSW0206-001X	TACT SWITCH		

△ Symbol No.	Part No.	Part Name	Description	Local
S604	NSW0206-001X	TACT SWITCH		
S605	NSW0206-001X	TACT SWITCH		
S606	NSW0206-001X	TACT SWITCH		
S607	NSW0206-001X	TACT SWITCH		
S608	NSW0206-001X	TACT SWITCH		
S609	NSW0206-001X	TACT SWITCH		
S610	NSW0206-001X	TACT SWITCH		
S611	NSW0206-001X	TACT SWITCH		
S612	NSW0206-001X	TACT SWITCH		
S613	NSW0206-001X	TACT SWITCH		
S614	NSW0206-001X	TACT SWITCH		
S616	NSW0206-001X	TACT SWITCH		
S617	NSW0206-001X	TACT SWITCH		

Front end board

△ Symbol No.	Part No.	Part Name	Description	Local
IC201	BA5835FM-X	IC		
IC251	BD6671FM-X	IC		
IC301	MN2DS0003AA-H	IC		
IC302	BA00HC5WF-X	IC		
IC304	S-80827CNNB-G-W	IC		
IC398	SG32M90TFIR31G	IC(PROGRAMED)		
IC399	K4S281632F-UC75	IC(DIGITAL)		
IC399	or EDS1216AATA-75	IC(DIGITAL)		
IC401	AK4385ET-X	IC		
IC411	NJM4580V-X	IC		
IC481	BR93L66F-W-X	IC(DIGITAL)		
Q101	2SB1424/R/-W	TRANSISTOR		
Q102	2SC4617/R/-X	TRANSISTOR		
Q103	2SB1424/R/-W	TRANSISTOR		
Q104	2SC4617/R/-X	TRANSISTOR		
Q105	2SK3019-X	MOS FET		
Q106	2SK3019-X	MOS FET		
Q107	2SC4617/R/-X	TRANSISTOR		
Q231	DTC114EE-X	DIGI TRANSISTOR		
Q301	DTC144EE-X	DIGI TRANSISTOR		
Q302	DTC144EE-X	DIGI TRANSISTOR		
C1	NCB31CK-104X	C CAPACITOR	0.1uF 16V K	
C2	NCB31CK-104X	C CAPACITOR	0.1uF 16V K	
C3	NCB31CK-104X	C CAPACITOR	0.1uF 16V K	
C4	NCB31CK-104X	C CAPACITOR	0.1uF 16V K	
C5	NCB31CK-104X	C CAPACITOR	0.1uF 16V K	
C6	NCB31CK-104X	C CAPACITOR	0.1uF 16V K	
C7	NCB31CK-104X	C CAPACITOR	0.1uF 16V K	
C8	NCB31CK-104X	C CAPACITOR	0.1uF 16V K	
C9	NCB31CK-104X	C CAPACITOR	0.1uF 16V K	
C10	NCB31CK-104X	C CAPACITOR	0.1uF 16V K	
C11	NCB31CK-104X	C CAPACITOR	0.1uF 16V K	
C12	NCB31CK-104X	C CAPACITOR	0.1uF 16V K	
C13	NCB31CK-104X	C CAPACITOR	0.1uF 16V K	
C14	NCB31CK-104X	C CAPACITOR	0.1uF 16V K	
C15	NCB31CK-104X	C CAPACITOR	0.1uF 16V K	
C16	NCB31CK-104X	C CAPACITOR	0.1uF 16V K	
C17	NCB31CK-104X	C CAPACITOR	0.1uF 16V K	
C18	NCB31CK-104X	C CAPACITOR	0.1uF 16V K	
C19	NCB31CK-104X	C CAPACITOR	0.1uF 16V K	
C20	NCB31CK-104X	C CAPACITOR	0.1uF 16V K	
C21	NCB31CK-104X	C CAPACITOR	0.1uF 16V K	
C102	NCB31CK-104X	C CAPACITOR	0.1uF 16V K	
C103	NCB31CK-104X	C CAPACITOR	0.1uF 16V K	
C104	NCB31CK-104X	C CAPACITOR	0.1uF 16V K	
C105	NBE41AM-476X	TA E CAPACITOR	47uF 10V M	
C106	NBE41AM-476X	TA E CAPACITOR	47uF 10V M	
C108	NBE41AM-476X	TA E CAPACITOR	47uF 10V M	
C111	NCB31CK-104X	C CAPACITOR	0.1uF 16V K	
C112	NCB31CK-104X	C CAPACITOR	0.1uF 16V K	
C113	NCB31CK-104X	C CAPACITOR	0.1uF 16V K	
C201	NEAF1CM-107X	E CAPACITOR	100uF 16V M	
C202	NCB31CK-104X	C CAPACITOR	0.1uF 16V K	

Block No. [0][5]

△ Symbol No.	Part No.	Part Name	Description	Local	△ Symbol No.	Part No.	Part Name	Description	Local
C203	NCS31HJ-271X	C CAPACITOR	270pF 50V J		C398	NCB31CK-104X	C CAPACITOR	0.1uF 16V K	
C204	NDC31HJ-151X	C CAPACITOR	150pF 50V J		C399	NCB31CK-104X	C CAPACITOR	0.1uF 16V K	
C205	NCB31HK-681X	C CAPACITOR	680pF 50V K		C401	NCB31CK-104X	C CAPACITOR	0.1uF 16V K	
C206	NCB31HK-561X	C CAPACITOR	560pF 50V K		C402	NBE41AM-476X	TA E CAPACITOR	47uF 10V M	
C211	NEAF1CM-107X	E CAPACITOR	100uF 16V M		C403	NCB31HK-331X	C CAPACITOR	330pF 50V K	
C212	NCB31CK-104X	C CAPACITOR	0.1uF 16V K		C404	NCB31CK-473X	C CAPACITOR	0.047uF 16V K	
C213	NCB31CK-104X	C CAPACITOR	0.1uF 16V K		C411	NCB31CK-104X	C CAPACITOR	0.1uF 16V K	
C221	NCB31HK-223X	C CAPACITOR	0.022uF 50V K		C412	NBE41AM-476X	TA E CAPACITOR	47uF 10V M	
C222	NCB31HK-103X	C CAPACITOR	0.01uF 50V K		C421	NCB31CK-104X	C CAPACITOR	0.1uF 16V K	
C251	NCB31CK-104X	C CAPACITOR	0.1uF 16V K		C422	NBE41AM-476X	TA E CAPACITOR	47uF 10V M	
C252	NEAF1CM-107X	E CAPACITOR	100uF 16V M		C431	NCB31HK-332X	C CAPACITOR	330pF 50V K	
C253	NCB31CK-104X	C CAPACITOR	0.1uF 16V K		C432	NCS31HJ-471X	C CAPACITOR	470pF 50V J	
C254	NBE21AM-106X	TA E CAPACITOR	10uF 10V M		C433	NCS31HJ-471X	C CAPACITOR	470pF 50V J	
C255	NCB31CK-104X	C CAPACITOR	0.1uF 16V K		C451	NCB31CK-104X	C CAPACITOR	0.1uF 16V K	
C256	NCB31CK-473X	C CAPACITOR	0.047uF 16V K		C452	NCB31CK-104X	C CAPACITOR	0.1uF 16V K	
C257	NCB31HK-102X	C CAPACITOR	1000pF 50V K		C453	NCB31CK-104X	C CAPACITOR	0.1uF 16V K	
C258	NCB31HK-102X	C CAPACITOR	1000pF 50V K		C454	NCB31CK-104X	C CAPACITOR	0.1uF 16V K	
C259	NCB31HK-102X	C CAPACITOR	1000pF 50V K		C481	NCB31CK-104X	C CAPACITOR	0.1uF 16V K	
C264	NCB31HK-103X	C CAPACITOR	0.01uF 50V K		C491	NCB31CK-104X	C CAPACITOR	0.1uF 16V K	
C265	NCB31CK-104X	C CAPACITOR	0.1uF 16V K		C492	NCB31CK-104X	C CAPACITOR	0.1uF 16V K	
C266	NCB31CK-104X	C CAPACITOR	0.1uF 16V K		C521	NCB31CK-104X	C CAPACITOR	0.1uF 16V K	
C267	NCB31HK-103X	C CAPACITOR	0.01uF 50V K		C522	NBE41AM-476X	TA E CAPACITOR	47uF 10V M	
C268	NCB31HK-153X	C CAPACITOR	0.015uF 50V K		C531	NCB31HK-332X	C CAPACITOR	330pF 50V K	
C301	NEAF0JM-227X	E CAPACITOR	220uF 6.3V M		C532	NCS31HJ-471X	C CAPACITOR	470pF 50V J	
C302	NBE40JM-476X	TA E CAPACITOR	47uF 6.3V M		C533	NCS31HJ-471X	C CAPACITOR	470pF 50V J	
C305	NCB31CK-104X	C CAPACITOR	0.1uF 16V K		R101	NRSA63J-0R0X	MG RESISTOR	0Ω 1/16W J	
C307	NCB31CK-104X	C CAPACITOR	0.1uF 16V K		R103	NRSA63D-242X	MG RESISTOR	2.4kΩ 1/16W D	
C308	NCB31CK-104X	C CAPACITOR	0.1uF 16V K		R104	NRSA63D-302X	MG RESISTOR	3kΩ 1/16W D	
C309	NCB31CK-104X	C CAPACITOR	0.1uF 16V K		R105	NRS125J-120X	MG RESISTOR	12Ω 1/2W J	
C310	NCB31HK-102X	C CAPACITOR	1000pF 50V K		R106	NRSA63J-2R2X	MG RESISTOR	2.2Ω 1/16W J	
C311	NCB31CK-104X	C CAPACITOR	0.1uF 16V K		R107	NRSA63J-102X	MG RESISTOR	1kΩ 1/16W J	
C312	NCB21CK-105X	C CAPACITOR	1uF 16V K		R108	NRSA63J-471X	MG RESISTOR	470Ω 1/16W J	
C313	NCB31CK-104X	C CAPACITOR	0.1uF 16V K		R109	NRSA63J-331X	MG RESISTOR	330Ω 1/16W J	
C314	NCB31CK-104X	C CAPACITOR	0.1uF 16V K		R110	NRSA63J-0R0X	MG RESISTOR	0Ω 1/16W J	
C315	NCB31CK-104X	C CAPACITOR	0.1uF 16V K		R111	NRSA63D-242X	MG RESISTOR	2.4kΩ 1/16W D	
C316	NCB31CK-104X	C CAPACITOR	0.1uF 16V K		R112	NRSA63D-302X	MG RESISTOR	3kΩ 1/16W D	
C317	NCB31CK-104X	C CAPACITOR	0.1uF 16V K		R113	NRS125J-120X	MG RESISTOR	12Ω 1/2W J	
C318	NCB31CK-104X	C CAPACITOR	0.1uF 16V K		R114	NRSA63J-2R2X	MG RESISTOR	2.2Ω 1/16W J	
C319	NCB31CK-104X	C CAPACITOR	0.1uF 16V K		R115	NRSA63J-102X	MG RESISTOR	1kΩ 1/16W J	
C320	NCB31CK-104X	C CAPACITOR	0.1uF 16V K		R116	NRSA63J-471X	MG RESISTOR	470Ω 1/16W J	
C321	NCB31CK-104X	C CAPACITOR	0.1uF 16V K		R117	NRSA63J-331X	MG RESISTOR	330Ω 1/16W J	
C322	NCB31CK-104X	C CAPACITOR	0.1uF 16V K		R118	NRSA63J-0R0X	MG RESISTOR	0Ω 1/16W J	
C323	NCB31CK-104X	C CAPACITOR	0.1uF 16V K		R119	NRSA63J-0R0X	MG RESISTOR	0Ω 1/16W J	
C324	NCB21CK-105X	C CAPACITOR	1uF 16V K		R120	NRSA63J-0R0X	MG RESISTOR	0Ω 1/16W J	
C325	NDC31HJ-100X	C CAPACITOR	10pF 50V J		R122	NRSA63J-0R0X	MG RESISTOR	0Ω 1/16W J	
C326	NDC31HJ-100X	C CAPACITOR	10pF 50V J		R123	NRSA63J-0R0X	MG RESISTOR	0Ω 1/16W J	
C330	NCB31CK-104X	C CAPACITOR	0.1uF 16V K		R125	NRS125J-1R0X	MG RESISTOR	1Ω 1/2W J	
C331	NCB31CK-333X	C CAPACITOR	0.033uF 16V K		R126	NRSA63J-910X	MG RESISTOR	91Ω 1/16W J	
C332	NCB31CK-104X	C CAPACITOR	0.1uF 16V K		R127	NRSA63J-910X	MG RESISTOR	91Ω 1/16W J	
C333	NCB31CK-104X	C CAPACITOR	0.1uF 16V K		R128	NRSA63J-103X	MG RESISTOR	10kΩ 1/16W J	
C334	NCB31CK-104X	C CAPACITOR	0.1uF 16V K		R129	NRSA63J-104X	MG RESISTOR	100kΩ 1/16W J	
C335	NCB31CK-104X	C CAPACITOR	0.1uF 16V K		R130	NRSA63J-103X	MG RESISTOR	10kΩ 1/16W J	
C336	NCB31CK-104X	C CAPACITOR	0.1uF 16V K		R201	NRS125J-1R0X	MG RESISTOR	1Ω 1/2W J	
C337	NCB31HK-183X	C CAPACITOR	0.018uF 50V K		R202	NRSA63J-473X	MG RESISTOR	47kΩ 1/16W J	
C338	NCB31HK-562X	C CAPACITOR	5600pF 50V K		R203	NRSA63J-303X	MG RESISTOR	30kΩ 1/16W J	
C339	NCB31CK-104X	C CAPACITOR	0.1uF 16V K		R204	NRSA63J-273X	MG RESISTOR	27kΩ 1/16W J	
C340	NCB21CK-105X	C CAPACITOR	1uF 16V K		R205	NRSA63J-273X	MG RESISTOR	27kΩ 1/16W J	
C341	NCB21CK-105X	C CAPACITOR	1uF 16V K		R206	NRSA63J-0R0X	MG RESISTOR	0Ω 1/16W J	
C347	NCB31CK-104X	C CAPACITOR	0.1uF 16V K		R207	NRSA63J-0R0X	MG RESISTOR	0Ω 1/16W J	
C348	NCB31CK-104X	C CAPACITOR	0.1uF 16V K		R208	NRSA63J-203X	MG RESISTOR	20kΩ 1/16W J	
C349	NCB31CK-104X	C CAPACITOR	0.1uF 16V K		R209	NRSA63J-223X	MG RESISTOR	22kΩ 1/16W J	
C350	NCB31CK-104X	C CAPACITOR	0.1uF 16V K		R211	NRSA63J-0R0X	MG RESISTOR	0Ω 1/16W J	
C356	NCB21CK-105X	C CAPACITOR	1uF 16V K		R219	NRSA63J-153X	MG RESISTOR	15kΩ 1/16W J	
C358	NDC31HJ-5R0X	C CAPACITOR	5pF 50V J		R220	NRSA63J-183X	MG RESISTOR	18kΩ 1/16W J	
C359	NDC31HJ-5R0X	C CAPACITOR	5pF 50V J		R221	NRSA63J-103X	MG RESISTOR	10kΩ 1/16W J	
C364	NBE40JM-476X	TA E CAPACITOR	47uF 6.3V M		R222	NRSA63J-103X	MG RESISTOR	10kΩ 1/16W J	
C365	NCB31CK-104X	C CAPACITOR	0.1uF 16V K		R223	NRSA63J-0R0X	MG RESISTOR	0Ω 1/16W J	
C366	NCB21CK-105X	C CAPACITOR	1uF 16V K		R224	NRSA63J-103X	MG RESISTOR	10kΩ 1/16W J	
C369	NBE40JM-476X	TA E CAPACITOR	47uF 6.3V M		R231	NRSA63J-272X	MG RESISTOR	2.7kΩ 1/16W J	
C371	NCB21CK-105X	C CAPACITOR	1uF 16V K		R232	NRSA63J-153X	MG RESISTOR	15kΩ 1/16W J	
C380	NCB31CK-104X	C CAPACITOR	0.1uF 16V K		R233	NRSA63J-0R0X	MG RESISTOR	0Ω 1/16W J	
C384	NCB31CK-104X	C CAPACITOR	0.1uF 16V K		R234	NRSA63J-394X	MG RESISTOR	390kΩ 1/16W J	
C391	NCB31CK-104X	C CAPACITOR	0.1uF 16V K		R235	NRSA63J-682X	MG RESISTOR	6.8kΩ 1/16W J	
C392	NCB31CK-104X	C CAPACITOR	0.1uF 16V K		R251	NRS125J-R47X	MG RESISTOR	0.47Ω 1/2W J	
C393	NCB31CK-104X	C CAPACITOR	0.1uF 16V K		R252	NRSA63J-103X	MG RESISTOR	10kΩ 1/16W J	
C395	NCB31CK-104X	C CAPACITOR	0.1uF 16V K		R253	NRSA63J-0R0X	MG RESISTOR	0Ω 1/16W J	
C396	NCB31CK-104X	C CAPACITOR	0.1uF 16V K		R254	NRSA63J-103X	MG RESISTOR	10kΩ 1/16W J	
C397	NBE20JM-226X	TA E CAPACITOR	22uF 6.3V M						

△ Symbol No.	Part No.	Part Name	Description	Local	△ Symbol No.	Part No.	Part Name	Description	Local
R255	NRSA63J-203X	MG RESISTOR	20kΩ 1/16W J		R411	NRSA63J-100X	MG RESISTOR	10Ω 1/16W J	
R256	NRSA63J-470X	MG RESISTOR	47Ω 1/16W J		R421	NRSA63J-102X	MG RESISTOR	1kΩ 1/16W J	
R257	NRSA63J-0R0X	MG RESISTOR	0Ω 1/16W J		R422	NRSA63J-122X	MG RESISTOR	1.2kΩ 1/16W J	
R258	NRSA63J-103X	MG RESISTOR	10kΩ 1/16W J		R431	NRSA63J-472X	MG RESISTOR	4.7kΩ 1/16W J	
R259	NRSA63J-103X	MG RESISTOR	10kΩ 1/16W J		R432	NRSA63J-472X	MG RESISTOR	4.7kΩ 1/16W J	
R260	NRSA63J-470X	MG RESISTOR	47Ω 1/16W J		R433	NRSA63J-223X	MG RESISTOR	22kΩ 1/16W J	
R300	NRSA63J-0R0X	MG RESISTOR	0Ω 1/16W J		R434	NRSA63J-201X	MG RESISTOR	200Ω 1/16W J	
R301	NRSA63J-0R0X	MG RESISTOR	0Ω 1/16W J		R435	NRSA63J-472X	MG RESISTOR	4.7kΩ 1/16W J	
R303	NRSA63J-270X	MG RESISTOR	27Ω 1/16W J		R436	NRSA63J-201X	MG RESISTOR	200Ω 1/16W J	
R306	NRSA63J-102X	MG RESISTOR	1kΩ 1/16W J		R437	NRSA63J-472X	MG RESISTOR	4.7kΩ 1/16W J	
R307	NRSA63J-102X	MG RESISTOR	1kΩ 1/16W J		R438	NRSA63J-223X	MG RESISTOR	22kΩ 1/16W J	
R308	NRSA63J-223X	MG RESISTOR	22kΩ 1/16W J		R441	NRSA63J-0R0X	MG RESISTOR	0Ω 1/16W J	
R309	NRSA63J-104X	MG RESISTOR	100kΩ 1/16W J		R442	NRSA63J-0R0X	MG RESISTOR	0Ω 1/16W J	
R310	NRSA63J-102X	MG RESISTOR	1kΩ 1/16W J		R481	NRSA63J-103X	MG RESISTOR	10kΩ 1/16W J	
R312	NRSA63J-0R0X	MG RESISTOR	0Ω 1/16W J		R491	NRSA63D-103X	MG RESISTOR	10kΩ 1/16W D	
R313	NRSA63J-0R0X	MG RESISTOR	0Ω 1/16W J		R492	NRSA63D-512X	MG RESISTOR	5.1kΩ 1/16W D	
R314	NRSA63J-0R0X	MG RESISTOR	0Ω 1/16W J		R493	NRSA63D-223X	MG RESISTOR	22kΩ 1/16W D	
R315	NRSA63J-0R0X	MG RESISTOR	0Ω 1/16W J		R521	NRSA63J-102X	MG RESISTOR	1kΩ 1/16W J	
R316	NRSA63J-0R0X	MG RESISTOR	0Ω 1/16W J		R522	NRSA63J-122X	MG RESISTOR	1.2kΩ 1/16W J	
R317	NRSA63J-223X	MG RESISTOR	22kΩ 1/16W J		R531	NRSA63J-472X	MG RESISTOR	4.7kΩ 1/16W J	
R318	NRSA63D-332X	MG RESISTOR	3.3kΩ 1/16W D		R532	NRSA63J-472X	MG RESISTOR	4.7kΩ 1/16W J	
R319	NRSA63J-223X	MG RESISTOR	22kΩ 1/16W J		R533	NRSA63J-223X	MG RESISTOR	22kΩ 1/16W J	
R321	NRSA63J-0R0X	MG RESISTOR	0Ω 1/16W J		R534	NRSA63J-201X	MG RESISTOR	200Ω 1/16W J	
R322	NRSA63J-0R0X	MG RESISTOR	0Ω 1/16W J		R535	NRSA63J-472X	MG RESISTOR	4.7kΩ 1/16W J	
R323	NRSA63J-0R0X	MG RESISTOR	0Ω 1/16W J		R536	NRSA63J-201X	MG RESISTOR	200Ω 1/16W J	
R325	NRSA63J-181X	MG RESISTOR	180Ω 1/16W J		R537	NRSA63J-472X	MG RESISTOR	4.7kΩ 1/16W J	
R326	NRSA63J-101X	MG RESISTOR	100Ω 1/16W J		R538	NRSA63J-223X	MG RESISTOR	22kΩ 1/16W J	
R327	NRSA63J-101X	MG RESISTOR	100Ω 1/16W J		R605	NRSA63J-0R0X	MG RESISTOR	0Ω 1/16W J	
R328	NRSA63J-101X	MG RESISTOR	100Ω 1/16W J		R606	NRSA63J-0R0X	MG RESISTOR	0Ω 1/16W J	
R329	NRSA63J-101X	MG RESISTOR	100Ω 1/16W J						
R332	NRSA63J-102X	MG RESISTOR	1kΩ 1/16W J		L303	NQL044K-100X	COIL	0.26Ω 10uH K	
R333	NRSA63D-162X	MG RESISTOR	1.6kΩ 1/16W D		L305	NQL093K-1R8X	COIL	1.8uH K	
R334	NRSA63J-151X	MG RESISTOR	150Ω 1/16W J		L306	NQL093K-1R8X	COIL	1.8uH K	
R335	NRSA63J-151X	MG RESISTOR	150Ω 1/16W J		L307	NQL093K-1R8X	COIL	1.8uH K	
R336	NRSA63J-151X	MG RESISTOR	150Ω 1/16W J		L451	NQL044K-100X	COIL	0.26Ω 10uH K	
R337	NRSA63J-151X	MG RESISTOR	150Ω 1/16W J						
R338	NRSA63J-0R0X	MG RESISTOR	0Ω 1/16W J		CN101	QGF0501F8-30X	CONNECTOR	FFC/FPC (1-30)	
R339	NRSA63J-0R0X	MG RESISTOR	0Ω 1/16W J		CN201	QGF1038F2-11X	CONNECTOR	FFC/FPC (1-11)	
R340	NRSA63D-303X	MG RESISTOR	30kΩ 1/16W D		CN202	QGF0523F2-05W	CONNECTOR	FFC/FPC (1-5)	
R345	NRSA63J-0R0X	MG RESISTOR	0Ω 1/16W J		CN402	QGF0522F3-06W	CONNECTOR	FFC/FPC (1-6)	
R346	NRSA63J-473X	MG RESISTOR	47kΩ 1/16W J		CN403	QGF0534F3-45X	CONNECTOR	FFC/FPC (1-45)	
R347	NRSA63J-473X	MG RESISTOR	47kΩ 1/16W J		K101	NQR0007-002X	FERRITE BEADS		
R348	NRSA63J-473X	MG RESISTOR	47kΩ 1/16W J		K102	NQR0007-002X	FERRITE BEADS		
R349	NRSA63J-473X	MG RESISTOR	47kΩ 1/16W J		K301	NQR0502-001X	FERRITE BEADS		
R350	NRSA63J-181X	MG RESISTOR	180Ω 1/16W J		K311	NQR0129-002X	FERRITE BEADS		
R351	NRSA63J-102X	MG RESISTOR	1kΩ 1/16W J		K399	NQR0502-001X	FERRITE BEADS		
R352	NRSA63J-105X	MG RESISTOR	1MΩ 1/16W J		K401	NQR0022-005X	FERRITE BEADS		
R353	NRSA63J-101X	MG RESISTOR	100Ω 1/16W J		K402	NQR0022-005X	FERRITE BEADS		
R354	NRSA63J-101X	MG RESISTOR	100Ω 1/16W J		K403	NQR0022-005X	FERRITE BEADS		
R355	NRSA63J-0R0X	MG RESISTOR	0Ω 1/16W J		K404	NQR0022-005X	FERRITE BEADS		
R356	NRSA63J-0R0X	MG RESISTOR	0Ω 1/16W J		K405	NQR0022-005X	FERRITE BEADS		
R357	NRSA63J-0R0X	MG RESISTOR	0Ω 1/16W J		K406	NQR0022-005X	FERRITE BEADS		
R358	NRSA63J-0R0X	MG RESISTOR	0Ω 1/16W J		K407	NQR0022-005X	FERRITE BEADS		
R359	NRSA63J-181X	MG RESISTOR	180Ω 1/16W J		K425	NQL093K-1R8X	COIL	1.8uH K	
R360	NRSA63J-181X	MG RESISTOR	180Ω 1/16W J		K441	NQR0022-005X	FERRITE BEADS		
R361	NQL093K-1R8X	COIL	1.8uH K		K442	NQR0022-005X	FERRITE BEADS		
R362	NRSA63J-0R0X	MG RESISTOR	0Ω 1/16W J		K443	NQR0022-005X	FERRITE BEADS		
R363	NRSA63J-151X	MG RESISTOR	150Ω 1/16W J		K444	NQR0022-005X	FERRITE BEADS		
R364	NRSA63J-151X	MG RESISTOR	150Ω 1/16W J		K445	NQR0022-005X	FERRITE BEADS		
R365	NRSA63D-911X	MG RESISTOR	910Ω 1/16W D		K451	NQR0022-005X	FERRITE BEADS		
R366	NRSA63D-202X	MG RESISTOR	2kΩ 1/16W D		K452	NQR0022-005X	FERRITE BEADS		
R370	NRSA63J-103X	MG RESISTOR	10kΩ 1/16W J		K601	NQR0022-005X	FERRITE BEADS		
R372	NRSA63J-331X	MG RESISTOR	330Ω 1/16W J		SW4	NSW0184-001X	DETECT SW		
R373	NRSA63J-331X	MG RESISTOR	330Ω 1/16W J		SW5	NSW0183-001X	DETECT SW		
R380	NRSA63J-102X	MG RESISTOR	1kΩ 1/16W J		TH491	NAD0025-103X	N THERMISTOR	10kΩ	
R384	NRSA63J-102X	MG RESISTOR	1kΩ 1/16W J		X351	NAX0730-001X	CRYSTAL	27.000MHz	
R385	NRSA63J-102X	MG RESISTOR	1kΩ 1/16W J						
R386	NRSA63J-0R0X	MG RESISTOR	0Ω 1/16W J						
R390	NRSA63J-103X	MG RESISTOR	10kΩ 1/16W J						
R392	NRSA63J-101X	MG RESISTOR	100Ω 1/16W J						
R393	NRSA63J-0R0X	MG RESISTOR	0Ω 1/16W J						
R394	NRSA63J-0R0X	MG RESISTOR	0Ω 1/16W J						
R396	NRSA63J-473X	MG RESISTOR	47kΩ 1/16W J						
R399	NRSA63J-0R0X	MG RESISTOR	0Ω 1/16W J						
R401	NRSA63J-100X	MG RESISTOR	10Ω 1/16W J						
R402	NRSA63J-4R7X	MG RESISTOR	4.7Ω 1/16W J						
R403	NRSA63J-0R0X	MG RESISTOR	0Ω 1/16W J						
R404	NRSA63J-473X	MG RESISTOR	47kΩ 1/16W J						

Packing materials and accessories parts list

Block No. M 3 M M

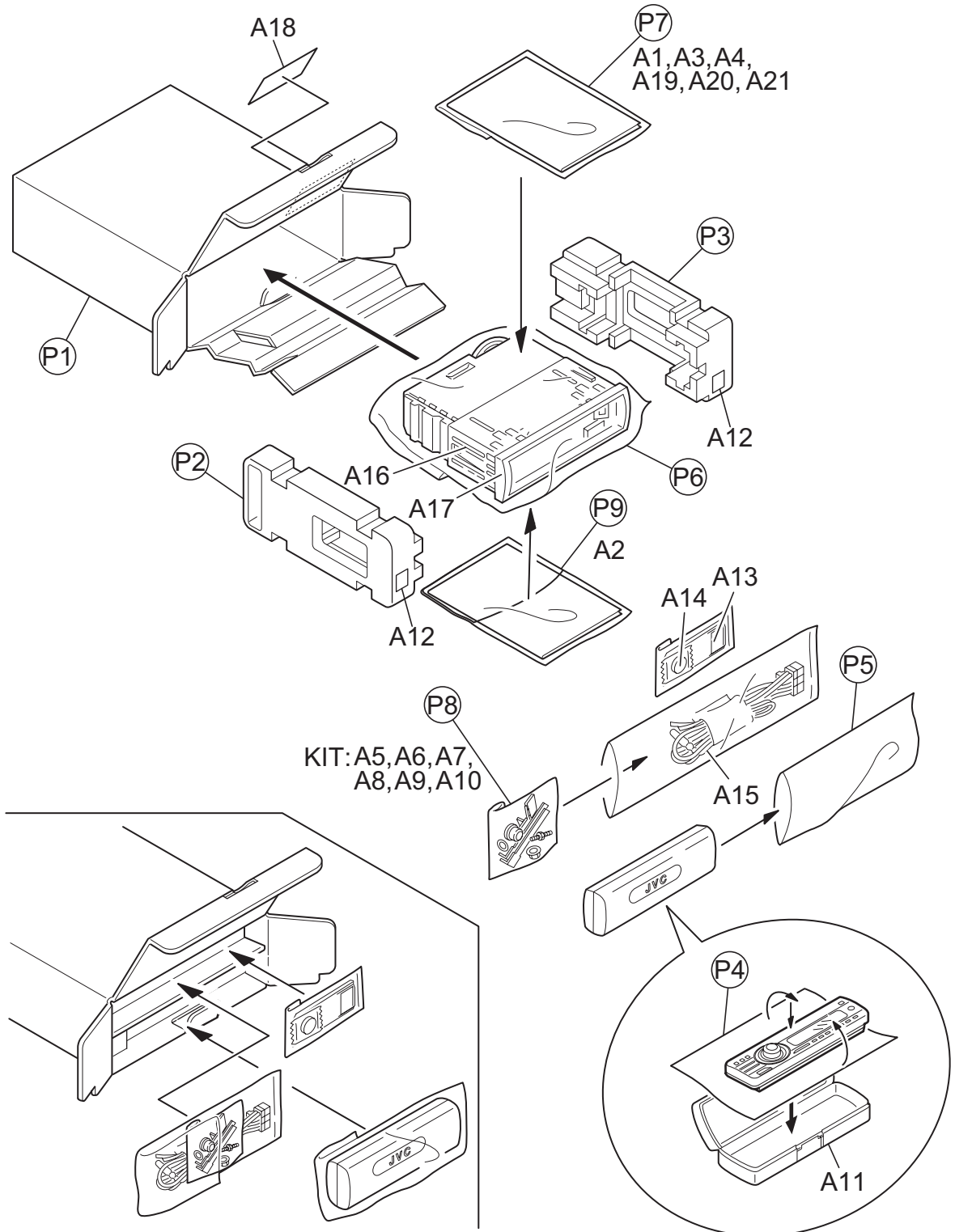

Packing and Accessories

Block No. [M][3][M][M]

△	Symbol No.	Part No.	Part Name	Description	Local
	A 1	GET0382-001A	INST BOOK	ENG FRE	DV5201EU,DV5202EU
	A 1	GET0383-001A	INST BOOK	ENG CHI(TAIWAN)	DV5205U,DV5206U,DV6205U,DV6206U
	A 1	GET0383-003A	INST BOOK	ENG CHI(TAIWAN)	DV5205UT,DV5206UT,DV6205UT,DV6206UT
	A 1	GET0383-004A	INST BOOK	ENG	DV6205A,DV6206A
	A 2	GET0382-002A	INST BOOK	SPA TUR PER	DV5201EU,DV5202EU
	A 2	GET0383-002A	INST BOOK	KOR THA ARA PER	DV5205U,DV5206U,DV6205U,DV6206U
	A 3	GET0383-005A	INSTALL MANUAL	ENG CHI(TAIWAN)	DV5205U,DV5205UT,DV5206U,DV5206UT, DV6205U,DV6205UT,DV6206U,DV6206UT
	A 3	GET0383-007A	INSTALL MANUAL	ENG	DV6205A,DV6206A
	A 4	GET0383-006A	INSTALL MANUAL	KOR THA ARA PER	DV5205U,DV5206U,DV6205U,DV6206U
	A 5	VKZ4027-202	PLUG NUT		
	A 6	VKH4871-003	MOUNT BOLT		
	A 7	VKZ4328-003	LOCK NUT		
	A 8	QYWWS53A008ZA	WASHER	0mm/5.3mm x	
	A 9	GE40130-002A	HOOK	(x2)	
	A 10	LV41478-002A	CORD CONNECTOR		
	A 11	FSJB3002-30C	HARD CASE		
	A 12	LV43644-001A	LABEL	(x2)	DV5205U,DV5206U,DV6205U,DV6206U
	A 13	RM-RK230	REMOCON UNIT		
	A 14	-----	BATTERY		
△	A 15	QAM0450-002	POWER CORD		DV5201EU,DV5202EU
△	A 15	QAM0455-002	POWER CORD		DV5205U,DV5205UT,DV5206U,DV5206UT, DV6205A,DV6205U,DV6205UT,DV6206A,DV6206U,DV6206UT
	A 16	GE20137-003A	MOUNTING SLEEVE		
	A 17	GE20149-013A	TRIM PLATE		DV5201EU
	A 17	GE20149-010A	TRIM PLATE		DV5202EU,DV5206U,DV5206UT,DV6206A,DV6206U,DV6206UT
	A 17	GE20149-007A	TRIM PLATE		DV5205U,DV5205UT,DV6205A,DV6205U,DV6205UT
	A 18	GE31574-037A	UT LABEL		DV5205UT
	A 18	GE31574-038A	UT LABEL		DV5206UT
	A 18	GE31574-039A	UT LABEL		DV6205UT
	A 18	GE31574-040A	UT LABEL		DV6206UT
	A 19	LVT1435-001A	INST SHEET		DV5201EU,DV5202EU
	A 20	GET0382-003A	INSTALL MANUAL	ENG FRE	DV5201EU,DV5202EU
	A 21	GET0382-004A	INSTALL MANUAL	SPA TUR PER	DV5201EU,DV5202EU
	KIT	SRW-ADV6160J	SCREW PART KIT	A5 A6 A7 A8 A9 A10	
	P 1	GE32197-001A	CARTON		DV5201EU
	P 1	GE32200-001A	CARTON		DV5202EU
	P 1	GE32211-001A	CARTON		DV5205U,DV5205UT
	P 1	GE32214-001A	CARTON		DV5206U,DV5206UT
	P 1	GE32205-001A	CARTON		DV6205A
	P 1	GE32203-001A	CARTON		DV6205U,DV6205UT
	P 1	GE32209-001A	CARTON		DV6206A
	P 1	GE32207-001A	CARTON		DV6206U,DV6206UT
	P 2	LV10777-003A	PAPER CUSHION		
	P 3	LV10778-003A	PAPER CUSHION		
	P 4	FSYH4036-068	SHEET		
	P 5	QPA01003003	POLY BAG	10cm x 30cm	
	P 6	QPC03004315P	POLY BAG	30cm x 43cm	
	P 7	FSPG4002-001	POLY BAG		
	P 8	QPA00801205	POLY BAG	8cm x 12cm	
	P 9	FSPG4002-001	POLY BAG		DV5201EU,DV5202EU,DV5205U,DV5206U,DV6205U,DV6206U